

WINE BUSINESS MONTHLY

April 2020 • \$5.95

The Industry's Leading Publication for Wineries and Growers

www.winebusiness.com

Packaging Technology

Using Near-field Communication to Collect Data, Prevent Theft and Engage Consumers

engagement | experiential brand tool | exclusive content

consumer data | media touchpoints

security | authenticity



How UC Davis is Creating Solutions to Industry Challenges

PLUS:

Equipment for Your Winery and Vineyard

The Latest Innovations Out of Unified

**Oak Providers Step Up
Alternative Options**

**Sprayers That Take the Hassle
Out of Application**



ALIENOR

HERITAGE COLLECTION

REVIVING THE MASTER CRAFTSMANSHIP AND AESTHETICS OF THE GREAT CLASSICS

Designed to celebrate the true essence of the Grands Crus, the Heritage Collection presents top-of-the-range glassware whose silhouettes hail back to the values of authenticity seen in the historical archives.

ALIENOR range stands out as a worthy heir to Bordeaux culture, with its characteristic “Saint-Émilion” shoulder, trunk-like base and a very deep punt with a small “push-out inside the punt”.

[CWINE]

Portocork
The first name in cork.

A TECHNICAL CORK WITH NO EQUAL

CUTTING EDGE

UTILIZE SUPERCRITICAL CO2 FOR THE ERADICATION OF TCA BELOW DETECTABLE LEVELS AND OVER 150 OTHER NON-DESIRABLE AROMATIC COMPOUNDS.

CONTROL

OFFERING THREE DIFFERENT OXYGEN TRANSFER RATES TO SUIT THE TARGET WINE STYLE AND AGING PROCESS.

CONSISTENCY

EACH CORK IS AN INDIVIDUALLY MOLDED, C.E. LIEGE CERTIFIED NATURAL CORK STOPPER WITH A MINIMUM CONTENT OF 75% NATURAL CORK.

CONFIDENCE

EACH CORK IS INDIVIDUALLY GUARANTEED TO MEET SPECIFICATIONS AND DELIVER ABSOLUTE SENSORY PERFORMANCE.



● SUPERCritical CO2 ● 3 PERMEABILITY LEVELS ● OVER 75% NATURAL CORK



**FILLED WITH
PASSION**



berlin[®]

PACKAGING

BerlinWinePackaging.com

Bottle your finest in ours.

You put a lot into your wine. We put a lot into our wine bottles. From beautiful glass to affordable closures to award-winning design, a tasteful first impression can get more people to taste the fruits of your labor.

Wine Bottles + Closures + Packaging + Design + Logistics + Quality

Wine in a Pandemic

IT'S BEEN A WILD couple of weeks: As we ship this issue, the coronavirus outbreak has been officially declared a pandemic by the World Health Organization, having spread beyond expectations.

To combat transmission of the coronavirus, colleges and universities are shuttering campuses and conducting classes online. Many companies are encouraging employees to work remotely. In the past 24 hours, the Trump administration banned most travel to the U.S. from Europe for 30 days; the NBA suspended the season; and California officials said gatherings of more than 250 people should be postponed or canceled through the end of the month. Organizers of smaller events were advised to implement “social distancing” of six feet per person.

This social distancing thing is going to take some getting used to.

The uncertainty caused by the outbreak has disrupted financial markets, with economists expecting a recession and the Fed cutting interest rates in response. Parts of China and most of Italy are on lockdown. These events are affecting travel, tourism, restaurant sales and wine sales. ProWein in Germany, along with other major wine events, is cancelled. Vinitaly is postponed until June; *Wine Business Monthly's* WiVi Central Coast trade show is rescheduled for late August.



There is a lot of anxiety about the virus, but there isn't a lot of data about it. We continue to monitor the situation and remain optimistic that we'll get through this soon.

Meanwhile, the matter at hand in the pages of *Wine Business Monthly*, as always, is making and selling great wine.

Toward that end, this issue takes a look at new wine-making technology, including products that caught our attention during the Unified Wine & Grape Symposium, new oak alternatives and a technical review of new wine micro-oxygenation equipment. We also have an in-depth look at a study of sprayer technologies for the vineyard.

Don't miss the article about the evolution of the viticulture and enology department UC Davis.

Here's to health and safety, and to the pursuit of wine-making excellence.

Cyril Penn – Editor

WINE BUSINESS MONTHLY

April 2020 • Volume XXVII No. 4

Editor

Cyril Penn

Editor-at-Large

Jim Gordon

Senior Technical Editor

Curtis Phillips

Managing Editor

Erin Kirschenmann

Staff Writer/News Editor

Kerana Todorov

Assistant Editor

Stacy Briscoe

PWV Editor

Don Neel

Eastern Editor

Linda Jones McKee

Copy Editor

Paula Whiteside

Contributors

Richard Carey

Mark Greenspan

Melissa Hansen

Gwen Hoheisel

Bill Pregler

Ted Rieger

Design & Production

Rebecca Arnn, Scott Summers

Director, Analytics Group

Alan Talbot

Editor, Wine Analytics Report

Andrew Adams

Winejobs.com Marketing Manager

Stacey Burkman

Web Developers

Burke Pedersen, Peter Scarborough

President & Publisher

Eric Jorgensen

Associate Publisher

Tamara Leon

ADVERTISING

Vice President International Relations

Jacques Brix

Sales Director

Amy Olmstead

Account Executives

Lydia Hall, Dana Horner,
Hooper Jones, Laura Lemos

Account Support Representative

Julia Willmers

Advertising Production Manager

April Kushner

ADMINISTRATION

Vice President – Data Management

Lynne Skinner

Circulation

Liesl Stevenson

Financial Controller

Katie Kohfeld

Events & Client Services

Tina Vierra

Database Content Analyst

Leila Bradaran

Public Relations

Mary Jorgensen

Chairman

Hugh Tietjen

Publishing Consultant

Ken Koppel

WINE BUSINESS MONTHLY

Now incorporating

WINES&VINES

For editorial or advertising inquiries,
call 707-940-3920 or email info@winebusiness.com

Copyright 2020

Wine Communications Group, Inc. Short passages can be quoted without permission but only if the information is attributed to *Wine Business Monthly*.

Wine Business Monthly is distributed through an audited circulation.

Those interested in subscribing for \$39/year, or \$58 for 2 years,
call 800-895-9463 or subscribe online at www.winebusiness.com.
You may also fill out the card in this magazine and send it in.

American made. Straight from the source.

Bottles 100% made in the USA.
Direct from us, the manufacturer.

Wineries of all sizes can experience the high level of attention, responsiveness and ease that comes with buying directly from Ardagh Group. As the largest producer of glass wine bottles made 100% in the USA, Ardagh Group has the resources to meet your unique needs in a highly-flexible manner. We even offer the option to order less than truckload quantities through our concierge service, Ardagh Direct.

Our experienced sales teams and manufacturing facilities are ready to serve you — right from the heart of the major North American wine regions. Give us a call today to learn more about our extensive product portfolio and the exceptional service you can expect from your local glass manufacturer.



winemaking

VITICULTURE & ENOLOGY

UNIVERSITY OF CALIFORNIA DAVIS

UC Davis Marks 140 Years of Service to the Wine Industry...16

New Faculty, Research, Programs Continue Leading Viticulture and Enology
Ted Rieger

Cool Products at the Unified Wine & Grape Symposium 24

RoboBottle Becomes a Family, More Tools for the Lab and Cellar
Curtis Phillips

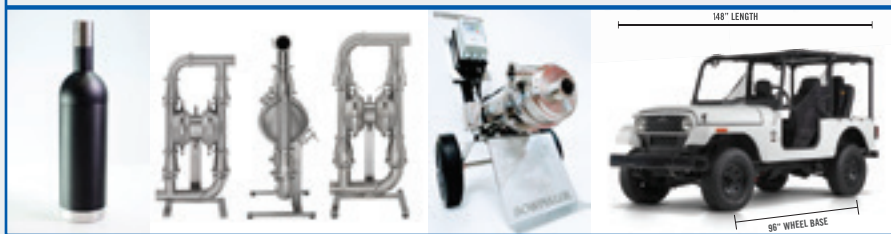

New Options in Oak Alternatives 30

Manufacturers Unveil Innovations at the Unified Wine & Grape Symposium
Jim Gordon



Must Keep Pumping Must 46

What type of pump is needed?
Curtis Phillips



A Technical Review of Parsec SRL and Its Products 50

Richard Carey

Technical Spotlight: Aperture Cellars 36

Winemaker Jesse Katz designs custom winery with a "no holds barred" approach to producing premium quality wine
Stacy Briscoe

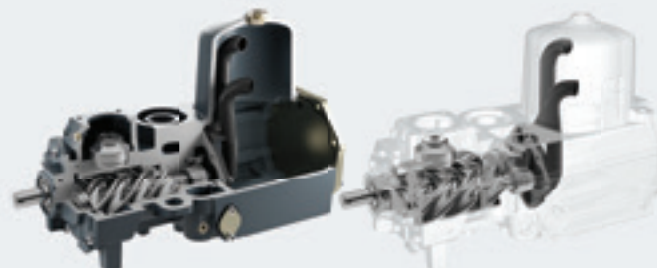

Compressor System Audits 56

Monitoring the Heart of Your Winery
Bill Pregler

Winemaker Trial



Cap Management Options for Red Wine Development 62

Production winemaker Andrew Brooks looks at two different extraction methods and how those methods affect the fermentation process and the resulting wine
Stacy Briscoe

THIS IS NO ORDINARY LABEL



BERGIN

SCREEN PRINTING & ETCHING

WWW.BERGINGLASS.COM

SCREEN PRINTING

PERMANENT | WATERPROOF | CELLARPROOF | WRINKLE PROOF | 360° DESIGN SURFACE

grape growing



The Climate is Changing, Whether We Like it or Not 68

What it means to winegrapes and what you can do about it
Mark Greenspan



Sudden Vine Collapse May Be Associated with Combination of Virus Pathogens 84

Lodi Meeting Updates Growers on Recent Research
Ted Rieger

departments

- month in review 6
- news 14
- people 108
- advertiser index 112
- jake lorenzo **In the Trenches** 114

sales & marketing



Marketing and Security Drive NFC-enabled Innovation. . . 88

Vendors incorporate the technology into their packaging suites while wineries take note
Erin Kirschenmann



Retail Sales Analysis Wine Sales Flat as Cans Gain Ground 96

Wines Vines Analytics

technology & business

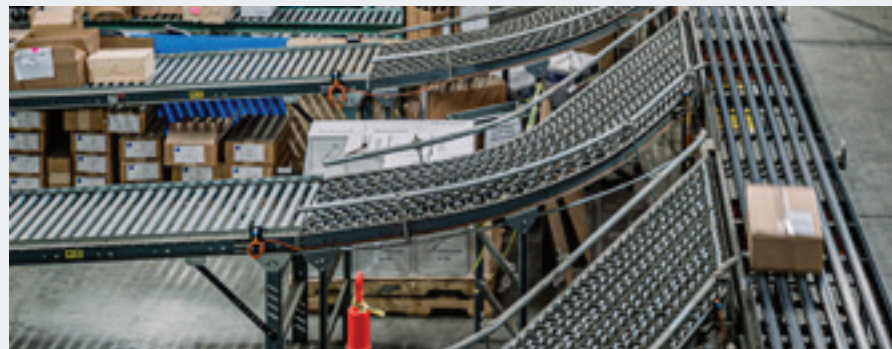

Growing with the DTC Universe. 98

Fulfillment companies expand services for wineries in this booming sales channel
Jim Gordon

Private Equity Still a Niche Player in Wine . . . 104

Kerana Todorov



winemaker of the month . . . 113

Bill Cooper, vintner,
Cooper-Garrod Estate Vineyards,
Saratoga, CA

NDtech[®]

The world's first natural cork with a non-detectable TCA performance*

GUARANTEED EXCELLENCE

THE WORLD'S BEST WINE STOPPER JUST GOT BETTER

The **NDtech** technology individually checks each wine stopper, allowing Amorim to deliver the world's first natural cork with a non-detectable TCA performance*. Winemakers rely on our dedication to supply the world's best stoppers. **NDtech** is the latest step to complement Amorim's proven preventive, curative and quality control methods, delivering the supreme guardian for wine.

For additional information on this wine packaging breakthrough, please visit amorimcork.com.

*releasable TCA content at or below the 0.5 ng/L quantification limit; analysis performed in accordance to ISO 20752.

AMORIM CORK

AMORIM CORK AMERICA | 360 Devlin Road, Napa, California 94558 | Tel: 707.224.6000 | info.acam@amorim.com | amorimcork.com

Caitriona Murphy, global brand manager, Malibu Rum, "Marketing and Security Drive NFC-enabled Innovation," page 88

"By transforming the one asset Malibu knows its consumers come into contact with, we're able to connect with our target audiences on a much deeper level, through the experiences we offer."

Mason Earles, assistant professor, UC Davis, "UC Davis Marks 140 Years of Service to the Wine Industry," page 16

"We want to look at opportunities for AI to accelerate precision viticulture and how to give growers more actionable data and analysis rather than just raw data."

Jesse Katz, founder, Aperture Cellars, "Technical Spotlight: Aperture Cellars," page 36

"In my opinion, one of the faults of the California wine region is that we blanket-plant to what's popular in that region."

Bourcard Nesin, beverage analyst, Rabobank, "Growing with the DTC Universe," Page 98

"I also think that some mid- to large-sized wineries may see the market opportunity and decide that the DTC market is large enough to risk a more rocky relationship with distributors," Nesin said. "That, in turn, could lead to more growth, innovation and investment in the DTC wine space."

Andrew Brooks, production winemaker, Ashes & Diamonds, "Winemaker Trial," page 62

"Red wine color and texture are shaped strongly by what we do or don't extract from the fruit during the fermentation process, so this [cap management] is a critical technique for us to understand."

Where is Your Glass Made?



Gallo Glass is at the center of it all, boasting glass made 100% in California. Partner with your local glass supplier.

Call 209-341-4527 (GLAS) to find out how.



MODESTO, CA | galloglass.com



Top Stories from **WINE BUSINESS**.com – In Case You Missed It

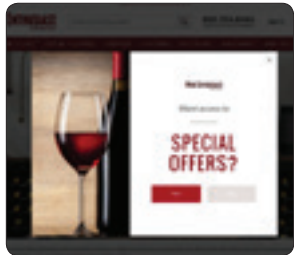

Wine Enthusiast Sued Over ADA Compliance

In February, a woman who was born blind filed a federal lawsuit in Connecticut against Wine Enthusiast Inc., according to court records. At issue is Wine Enthusiast's website www.wineenthusiast.com, an online catalog of products and services, as described by court records. The plaintiff, Anne West, a business owner based in Hartford, Conn., alleges Wine Enthusiast's catalog website is not accessible to individuals with visual disabilities and does not comply with the federal American with Disabilities Act, according to the complaint.



Wine Industry Events Cancelled Due to Coronavirus

ProWein 2020's organizers have cancelled this year's trade fair in Düsseldorf, Germany, citing the coronavirus outbreak. Messe Düsseldorf GmbH has scheduled the next ProWein show for March 21-23, 2021. ProWein 2020 had been set for March of this year. Another international trade show, Vinitaly, postponed its 2020 show, originally scheduled for March, to June 14-17, 2020, in Verona, Italy. In the United States, Taste Washington, a festival set in downtown Seattle, was also cancelled; the event coordinators cited growing concerns over the spread of the disease. There have been several other domestic events either postponed or cancelled this year, including Grounded Summit 2020, a conference focused on climate change, founded by vintner Julia Jackson.



Livermore Valley's Historic Concannon Vineyard on the Market

The Wine Group plans to sell historic Concannon Vineyard in the Livermore Valley, according to a real estate listing. The second largest winery in the Livermore Valley was founded in 1883, and its 230-acre property includes a tasting room, offices, two bottling lines, a tank farm and more than 180 acres of vineyards. The sales price for the property was not listed.



New Watershed Protection Initiative Proposed in Napa County

A new measure intended to protect the hillsides of the Napa Valley and the county's water resources may be on the Nov. 2020 ballot. A volunteer organization, the Napa Growers and Vintners for Responsible Agriculture, has until May 8 to collect 5,600 signatures from Napa County voters in order to place the "Napa County Water Sustainability Initiative of 2020" on the Nov. 3 ballot. Backers of the new initiative also campaigned for Measure C, the watershed protection ordinance, that was narrowly defeated in 2018.



Bundschu Acquires Valley of the Moon Winery

Bundschu Co., the parent company of family-owned Gundlach Bundschu of Sonoma, has purchased Rancho Agua Caliente's historic winery and vineyard in the Sonoma Valley. West Coast Partners LLC sold the property for an undisclosed price. The 60-acre property includes the now-closed Valley of the Moon Winery, a Zinfandel vineyard planted in 1940 and a barrel room built in 1863.



New Masters of Wines Named

The Institute of Masters of Wine in March announced seven new Masters of Wine, including two from the U.S. and one Canadian resident. The new Masters of Wine include Curtis Mann, Raley's director of alcohol and beverage, and Vanessa Conlin, head of Wine Access, a national direct and e-commerce wine retailer. Also named in March was Ross Wise, a New Zealand native who works as a winemaker and viticulturist in British Columbia's Okanagan Valley. There are 396 Masters of Wine in 30 countries, including 53 in the United States. [WBM](https://www.winebusiness.com)

A Great Glass of Wine is Made Possible by the Great Qualities of Glass



We offer the best in glass packaging through partnerships
with the best in the glass industry, including



- Glass is 100% recyclable and can be recycled endlessly.
- A recycled glass container is back on the shelf in as little as 30 days.
- About 80% of recovered glass containers are made into new glass bottles.
- With no chemical interactions between glass packaging and the contents inside, the products keep their strength, aroma, and flavor.
- Discerning consumers choose beverages packaged in glass.

WATERLOO CONTAINER
company
Supplier of Wine Bottles, Caps, Corks and Closures

888-539-3922 • waterloocontainer.com • Like us on Facebook 

UC Davis Marks 140 Years of Service to the Wine Industry

New Faculty, Research, Programs Continue Leading Viticulture and Enology

Ted Rieger

THE UNIVERSITY OF CALIFORNIA, DAVIS Department of Viticulture and Enology celebrates 140 years of service and contributions to the wine industry this month and will host an alumni day on campus on April 24 to mark the anniversary. On April 15, 1880, the California Legislature mandated the regents of the University of California to establish a program that provided instruction and research in viticulture and enology. Leaders in business and government, at the time, envisioned California's potential to become one of the world's foremost wine and grape producing regions.

The program was originally established at University of California, Berkeley. In 1935, the Department of Viticulture and Enology (V&E) was established at the UC Davis (UCD) campus, following the repeal of Prohibition, and is credited with re-starting California's wine industry. Early on, the department founders recognized that the quality of wine in the bottle directly related to the quality of the grapes in the vineyard, so the goal of the new educational program was to combine the sciences of viticulture and enology into a single research and teaching unit. To this day, the V&E department has taken a multi-disciplinary approach for teaching and research programs to cover all major sciences related to viticulture and enology. The faculty includes scientists from the fields of chemistry, genetics, microbiology, chemical engineering, horticulture, biochemistry, plant physiology and sensory science.

Reflecting upon the department's history and significance, department chair and professor, Dr. David E. Block, listed several important points:

- [“We’ve been helping the industry for 140 years, and we are a global leader in viticulture, enology, education and research.](#)
- [UCD’s research and its alumni are the foundation of the wine industry’s current success, and the return on investment in research is large.](#)
- [We’re going to supply solutions to current and future industry challenges.](#)
- [UCD is an excellent source for future employees. UCD graduates have a complete toolbox to be technically skilled and creative.”](#)

Ted Rieger, CSW, is a wine journalist based in Sacramento, California and has been a writer for wine industry media since 1988.



UC DAVIS

Block joined the UC Davis faculty in 1996 and holds a joint appointment with both the Department of Viticulture and Enology and the Department of Chemical Engineering and Materials Science. He has served as V&E Department chair since 2011. During his tenure with the V&E department, Block has been part of, and overseen major changes in, faculty, facilities and programs—some among the more significant changes in the department's history. These include the opening and operation of a new state-of-the-art teaching and research winery, the expansion and redevelopment of research and teaching vineyards on and off campus, a major expansion in extension programs for the industry and managing a turnover in half the department's faculty over the past eight years.

On the research front, Block observed: “Two of our main focus areas are sustainability and flavor. Most of our research is related to one of those two categories. With sustainability, it's how to get the same, or better, quality product with fewer inputs, such as chemicals, energy, water or labor—both in the vineyard and in the winery. Our other goal is understanding flavor enough to better control what comes out in the final wine product. We want to give winemakers better tools to predict what happens when they process wine in a certain way and help them do their jobs more effectively and creatively.” For both of these categories, research in genetics and developing technologies to better collect and analyze data will play major roles in understanding processes and developing tools to achieve sustainability and quality goals.



PROVEN WATERLESS, CHEMICAL-FREE TANK SANITIZATION TECHNOLOGY

AVAILABLE FOR LARGE TANKS, MID TO SMALL TANKS, AND BARRELS

Chemical-Free | Water & Energy Saving | Trackable Data

Blue Morph is validated sanitization technology that utilizes ultraviolet light to efficiently sanitize large and small tanks, as well as barrels without the use of water or chemicals. It is the only barrel sanitization method available which does not degrade the quality of the wood. Increased safety, decreased workload and impressive energy savings. Backed by ColloPack's technical expertise and after-sales support, BlueMorph UV is proven to save time, water, money and labor.



Faculty: Changing of the Guard

Although the V&E department's total number of faculty has remained at 15 for the past decade, the department has seen a major transition, with eight new faculty hired over as many years as others have retired. Long-time faculty who retired over the past four years include professors Douglas O. Adams, Linda F. Bisson, Roger Boulton, Mark A. Matthews, David R. Smart and Larry E. Williams.

"It's always scary to have a large turnover in personnel as an academic institution's reputation is largely based on the quality and expertise of its faculty," Block said. "But I think we've been very fortunate with the new faculty who have come on board to lead us into the future." Listed below are newer faculty

members, the years they joined the V&E department, their subject expertise and research focus areas.

Dario Cantu, associate professor (2012), is a plant biologist and geneticist. His research integrates systems biology and quantitative genetics and uses genomics to study the molecular networks underlying grapevine responses to the environment and stresses. His research involves identifying grapevine responses to fungal pathogens and the molecular determinants of fruit development and ripening.

"Dario has laid the groundwork to help understand the genomes of grape varieties. This will help us understand where pest resistance, drought resistance, flavor and other characteristics come from in grapes and in different grape varieties," Block said. This work will make genome information more useful, will help in sequencing genomes more rapidly and is expected to help expedite the breeding process to develop new grape varieties with desired traits.

"When Dario joined us in 2012, he had never worked with grapes before, and now he's become one of the top grape geneticists in the world in a very short time," Block said.

Ron C. Runnebaum, assistant professor (2015), is a chemical engineer who holds a joint appointment with the Department of Chemical Engineering and Materials Science. He is focusing on sustainable processing technologies and practices to reduce energy, inputs and waste in winery operations. These include carbon dioxide capture during fermentation, as well as more efficient methods and materials for wine stabilization and filtration.

Ben Montpetit, assistant professor (2016), is a microbiologist and yeast biologist, whose focus is on yeast responses to stress, including differences between yeast strains and differences in the same strain under different conditions.

Runnebaum and Montpetit are part of a research team that is evaluating the role of vineyard site (terroir) on Pinot Noir from 12 different vineyards in relation to wine chemistry (phenolics, volatile compounds and elemental profiles), wine sensory characteristics, and the impact of site on yeast fermentation kinetics and yeast gene expression. Block said the researchers will expand these studies to other grape varieties and sites.

setting the standard for oak alternatives

ēVOAK
Forward Thinking Oak Products

SENSORY SCIENCE . CREATIVE TECHNOLOGY . UNPARALLELED SELECTIONS . EXPERT ADVICE

ēVOAK IS DISTRIBUTED BY OAK SOLUTIONS GROUP

Historical Timeline Highlighting UCD Contributions

- **1930s:** Credited with restarting the California wine industry after Prohibition.
- **1940s:** Studies on the relationship between wine quality and climate led to recommendations of grape varieties for specific regions.
- **1950s:** Introduction of modern sanitation practices for winemaking that eliminated widespread vinegar contamination of wine.
- **1960s:** Introduction of sterile filtration to the California industry that eliminated many post-bottling problems and increased the market for table wines.
- **1970s:** Research on malolactic bacteria cultures improved control and helped avoid wine spoilage.
- **1980s:** The first standardized lexicon for wine sensory characteristics was established with the "Wine Aroma Wheel."
- **1990s:** DNA fingerprinting techniques revealed the parentage of Cabernet Sauvignon, Pinot Noir and other varieties. TCA assay was developed to measure and avoid cork taint.
- **2000s:** Quantitative Polymerase Chain Reaction (qPCR) tests were developed to quantify *Brettanomyces* and other wine microbes. Department led the effort to sequence 12 lactic acid bacteria genomes, including *Oenococcus oeni*. Adams-Harbertson assay is developed to quantify grape and wine phenolic profiles. Department offices and facilities moved to the new Robert Mondavi Institute (RMI) for Wine and Food Science complex on campus.
- **2010s:** Department designed, built and opened the world's first LEED Platinum winery as the Teaching and Research Winery at the RMI and expanded production and education opportunities at the adjacent 20-acre teaching and demonstration vineyard. Later, the Jess S. Jackson Sustainable Winery Building opened with the goal of taking the Teaching and Research Winery completely off the grid for energy and water. New rootstocks were developed with resistance to nematodes and fanleaf degeneration. Five new Pierce's Disease-resistant winegrape cultivars were developed and released. Yeast strains were developed to prevent development of the sensory defect hydrogen sulfide. Next-generation sequencing (NGS) was applied to vineyard and winery ecology. Technology for analyzing grape genome data was developed. The first comprehensive model for phenolic extraction in red wine was developed.

ADVANCED STORAGE

SmartBarrel[®]

Wine storage technology



**No headspace
No topping
Partial fill
No cleaning
Single-use liner**



IBC upto 330 gallon, Microoxygenation



Liner-in-barrel storage upto 60 gallon

Advanced Wine Technology

GO
fermentor[®]
A REVOLUTION IN WINEMAKING

www.GOfermentor.com 877 377 5359

US patent 9,260,682 9,611,452 9,802,805 France 1461410 Australia 2014268161

Megan Bartlett, assistant professor (2019), is a plant biologist focused on plant-water relations. Her work involves modeling vine responses to drought and heat stress and identifying traits to develop more stress-tolerant cultivars.

Elisabeth Forrestel, assistant professor (2019), is examining plant adaptation and climate response, as well as the evolutionary, physiological and anatomical basis of drought tolerance in wild grapevines.

“We have a long history in the department of studying plant/water relations,” Block said. “Megan will be taking more of a mathematical modeling approach, and Beth will be taking an ecological and evolutionary approach to understanding how grapes can adapt to climatic and environmental changes.” Their work is expected to complement the work of professor Andy Walker in breeding grapevines that are resistant to drought, heat and salt.

Mason Earles, assistant professor, joined the V&E department in Fall 2019. He is the newest faculty member and holds a joint faculty position with the Department of Biological and Agricultural Engineering. He will take research in a new direction as he leads the new Plant Artificial Intelligence (AI) and Biophysics Lab located at the Robert Mondavi Institute (RMI).

The Plant AI and Biophysics Lab aims to develop lower-cost agricultural sensing and automation systems, including hardware and software, and develop algorithms that can monitor and predict vine and grape status, such as stress and yields, and track and predict grape ripeness, development and quality. “We want to look at opportunities for AI to accelerate precision viticulture and how to give growers more actionable data and analysis rather than just raw data,” Earles said.

Earles is also working with associate professor Stavros G. Vougioukas of the Department of Biological and Agricultural Engineering, who specializes in developing robotics, mechanization and automation for specialty crops. They plan to build a small autonomous robot to test in campus vineyards this year. “There is a lot of drone and aerial-based technology on the market, but the biggest challenge is getting ground-truth data to validate aerial data,” Earles said. “Growers want to know things like actual yields on the ground, and they want to trust the data they have. We want to generate better and more ground-truth data that growers can trust and use for decision making.”

Earles will teach a precision viticulture class within the V&E department and a class in data science for agricultural and environmental technology within the Biological and Agricultural Engineering Department.

V&E Extension

The department’s extension and outreach activities have increased significantly from one traditional annual research forum, Recent Advances in Viticulture and Enology (RAVE), to nearly 15 educational events per year, both on and off campus. These include the Wine Flavor 101 series on campus, started and coordinated by professor Linda Bisson (now emeritus) and V&E extension program director Kay Bogart, who retired in July 2019. A replacement for Bogart is expected to be hired in early 2020.

LIQUID NITROGEN DOSING

regardless of your package or closure preference

- Minimize dissolved oxygen
- Extend shelf life
- Purge O₂ from empty bottles
- Purge O₂ from headspace
- Pressurize light-weight aluminum cans

Since 1958



**VACUUM
BARRIER VBC**
CORPORATION

4 Barten Lane, Woburn, MA 01801
T 781 933 3570 | F 781 932 9428
sales@vacuumbarrier.com



vacuumbarrier.com

Cooperative Extension (CE) enology associate specialist Dr. Anita Oberholster joined the department in 2011 to coordinate enology extension programs. She has led numerous Wine Flavor 101 meetings on campus and is a frequent speaker at symposia and regional meetings throughout the state. Her research includes evaluating the effects of vineyard conditions, winery practices and wine processing techniques on wine chemistry, quality and sensory characteristics, including flavor and mouthfeel.

“Anita has done an excellent job of working with the industry and figuring out what it needs in terms of research and extension priorities. She is leading key research in studying the impacts of Red Blotch Virus and smoke taint on wine quality and sensory characteristics,” Block said.

CE viticulture associate specialist Dr. S. Kaan Kurtural joined the Department in 2015 and is based at the UC Davis Oakville Station in Napa Valley—a 40-acre research vineyard and lab facility—where he conducts research and demonstrations with new vineyard sensor and monitoring technologies and mechanized vineyard management. In addition to his viticultural research work and field trials, Kurtural coordinates viticulture extension programs on campus and field days at Oakville.

CE viticulture specialist Dr. Matthew W. Fidelibus performs research at the Kearney Agricultural Research and Extension Center (KARE) in Fresno County. He is currently studying the effects of viticultural practices and environmental conditions in the vineyard on yield and quality for raisin, table and winegrapes. He coordinates extension meetings and field days held at KARE with a focus on viticulture issues for San Joaquin Valley grape growers.

The department’s “On the Road” extension series began in 2012 and includes four to five single-day meetings held each year in different wine production regions throughout California, coordinated by Dr. Karen L. Block, V&E director of industry relations, in conjunction with local viticulture farm advisors. The department is also looking to provide extension opportunities through electronic delivery, such as webinars and other online media, to expand information access to the industry.

Research: Productivity and Impact

Publication of research articles by UCD faculty and researchers in peer-reviewed journals is a measure of the school’s productivity. In addition, and perhaps even more importantly, citations or references of these published research articles by other researchers worldwide are a measure of UCD’s impact in the fields of viticulture and enology.

As a gauge of UCD’s productivity and impact in research, Block has reviewed data from the Web of Science website, a comprehensive database and search engine of publications and citation data for many different academic disciplines going back as far as 1900. Block generated data for the top institutions worldwide via a search of the terms “grape,” “vitis,” “vinifera,” “wine,” “viticulture” and “enology.”



A FINE WINE DESERVES A FINE CODE

MULTIPLE WAYS TO MAKE YOUR MARK

Need a way to discreetly mark your bottles for traceability? The SQ-Laser from Squid Ink® provides a high quality, clean option for permanently marking date codes, lot numbers, vintages, and more directly on your wine bottle.

Looking to make your mark with ink jet? The JetStream™ CIJ printer is an excellent solution to print up to 5 lines of durable alphanumeric codes directly on glass or on your wine label.

Don't forget about your shipping cases! Replace costly labels with inexpensive hi-resolution ink jet printing. The CoPilot® 500 prints text, date codes, barcodes, images and more at a fraction of the cost of print and apply labels or preprinted cases.

To learn more please visit www.squidink.com/wine or call **1.800.877.5658**

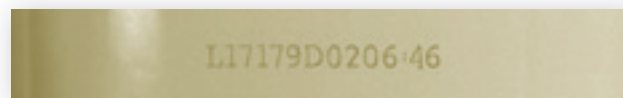

Laser code on bottle

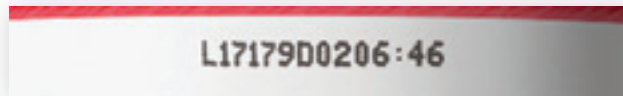

CIJ code on label



SQ-LASER
Laser Coding for Discreet Primary Marking



JETSTREAM
CIJ Small Character Coding for Primary Marking



COPILOT 500
Hi-Resolution Ink Jet Printing for Secondary Cases



www.squidink.com
1.800.877.5658

OIV Wine Marketing

July 20-24

Discover from top industry experts how to successfully create a brand, market and sell wine.

cpe.ucdavis.edu/winemarketing



UCDAVIS

Continuing and Professional Education

UC Davis Marks 140 Years of Service to the Wine Industry

Based on Web of Science data through 2018, UCD faculty and researchers have published 2,635 research articles in these subject areas, placing UCD third among all institutions listed in this subject area.

Looking at data for research impacts of individual academic institutions, the cumulative total of citations, through 2018, of UCD research publications is about 80,000, which leads all other individual academic institutions. The University of Bordeaux was second with nearly 30,000 citations; Cornell was third with about 20,000 citations.

Based on individual academic institutions worldwide, these statistics indicate that UCD has two times the productivity and more than 2.5 times the impact of the next leading institutions in viticulture and enology research.

Research: Return on Investment

The University of California Agricultural Issues Center has performed several case studies to assess the economic effects of the V&E department's research, outreach and teaching activities on the California grape and wine industry. Two studies completed in 2015 by Dr. James Lapsley, a researcher at the UC Agricultural Issues Center and adjunct associate professor in the V&E Department (now emeritus), and Dr. Daniel Sumner, director of the UC Agricultural Issues Center and professor in the Department of Agricultural and Resource Economics, show how large the return on investment in department research has been for the industry in several areas.

One study, "Contributions of UC Research and Outreach to Expansion of Chardonnay Grapes in California and Gains to Winegrape Producers," estimated that two Chardonnay selections identified and evaluated by UC Davis professor Dr. Harold Olmo (who passed in 2006), through field trials beginning in the 1950s, resulted in economic value of \$14.5 billion to the California wine industry over a period of about 45 years—and they continue to provide value to this day.

The two selections, now called FPS 04 and FPS 05, were Wenté clones evaluated in a field trial at a Louis Martini vineyard in Carneros, Napa County. These selections were heat-treated and virus-tested, then released to commercial nurseries for propagation and sale in 1969. Olmo's research and evaluations enabled the industry to have better yielding clones of Chardonnay to plant across multiple regions, and allowed growers to change from other varieties to Chardonnay, expand white wine production, and led to Chardonnay becoming the dominant white winegrape variety in California and the leading white wine in the U.S. These two selections grew in use, accounting for 75 percent of all Chardonnay grown in California, and they continue to be industry favorites.

Another economic case study related to cork taint produced the report, "Contributions of UC Research and Extension to Reduction of Cork Taint and an Estimation of the Gains to California Wine Producers and Consumers." In 1997, UC Davis researchers, in collaboration with ETS Laboratories in St. Helena, Calif., developed an analytical technique to detect 2,4,6-trichloroanisole (TCA) in cork used for wine closures. California cork suppliers began using the technique in 2002 for cork quality control. By 2006, the share of TCA-tainted corks had fallen from an estimated 5 percent to about 1 percent. The report stated, "If cork taint had continued at the higher levels, we calculate that cork taint would have spoiled California wine sold in the U.S. worth about \$3.4 billion in the period from 2006 to 2012. Reduced cork taint enhanced consumers' enjoyment of wine and increased their willingness to pay for wine."

feed
the
beast

NEW!

OLT™ MOG REMOVER FOR OPTICAL SORTERS

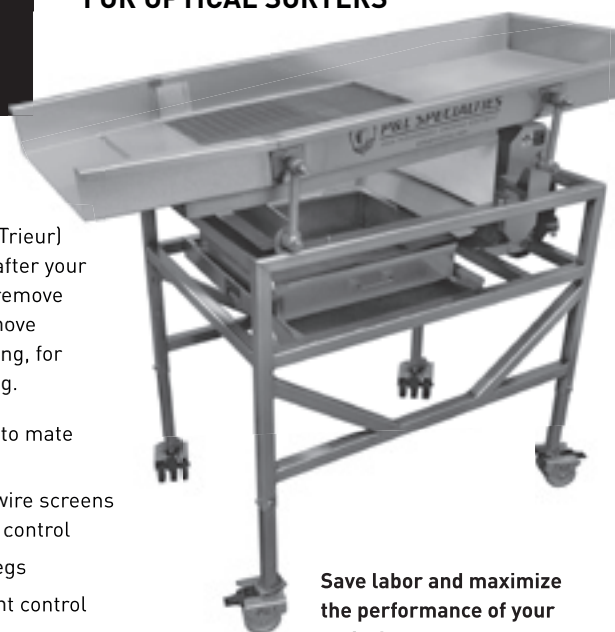

The OLT™ (Optical Le Trier) MOG Remover works after your destemmer to gently remove MOG. Whole berries move evenly, without clumping, for effective optical sorting.

- Designed expressly to mate with optical sorters
- Removable wedge-wire screens in two sizes for fine control
- Adjustable-height legs
- 25' tethered pendant control
- Juice collection

Save labor and maximize the performance of your optical sorter



P&L SPECIALTIES™

HIGH-PERFORMANCE CRUSHPAD EQUIPMENT

www.pnlspecialties.com ■ p. 707 573 3141 ■ f. 707 573 3140

1650 Almar Pkwy, Santa Rosa, CA 95403

Licenses: CA #803431, WA #PLSPELS923BZ, OR #180330



UC DAVIS

Curriculum

Block said the primary goals of the V&E department's curriculum are to provide students a core of basic sciences, extensive hands-on experience and problem-solving skills to enhance creativity. The department offers more than 25 courses for undergraduate and Master's candidates, including lab classes and hands-on vineyard classes.

"Other academic institutions, both in the U.S. and internationally, look to UC Davis as the example to develop their own curricula and course content. We want to be sure we're on the cutting-edge, and stay on the cutting-edge, in this area," Block said. The department has made significant curriculum updates and changes, based in large part upon industry stakeholder and alumni input from focus group meetings held throughout California in recent years.

The VEN 124 wine production course has changed to now require students to individually make their own red and white wines, in addition to the wines produced as a class. The VEN 115 viticulture class now covers all types of grapes (wine, table and raisin) and is expanding to include precision viticulture practices, mechanization and automation.

New courses have been added in soils and climate, as well as winery post-fermentation processing. Specialized educational opportunities are offered that include a regulatory seminar focused on permitting and regulatory requirements for starting a winery, and wine business classes that include accounting and finances offered in conjunction with the UC Davis Graduate School of Management.

Between 50 and 65 students have graduated from the department each year for the past 10 years. UC Davis has graduated about 2,400 students in viticulture and enology in total, the majority since about 1965. Most graduates went on to work in the grape and wine industry, holding positions in production and management at wineries of all sizes; many have started their own successful wineries, vineyard management companies or act as industry consultants.

Although UC Davis has had much success, achieved many accomplishments and has a lot to celebrate this year, Block emphasized the importance of moving forward: "We never want to be resting on our laurels. We always want to be at the forefront of research, extension and academics for the grape and wine industry," he said. [WBM](#)

For a complete list of faculty and more information on the UC Davis Department of Viticulture and Enology news and programs, see wineserver.ucdavis.edu.



The Wood Specialists

A different approach to coopering

We consider the natural oak attributes and terroir just like you consider your fruit and vineyards

Let your wine be the focus

It's a conversation

Let's have one

Michael Weyna
Tonnellerie de Mercurey USA, Inc
m.weyna@tonnellerie-de-mercurey.com
707.346.3932 office 707.246.1708 cell

Corey Guinnee, OREGON
Tonnellerie de Mercurey, Oregon
corey@enologygroup.com
971.237.5071

www.tonnellerie-de-mercurey.com

Cool Products at the Unified Wine & Grape Symposium

RoboBottle Becomes a Family, More Tools for the Lab and Cellar

Curtis Phillips



Curtis Phillips, an editor for *Wine Business Monthly* since 2000, is a graduate of UC Davis, and has been a winemaker since 1984 and an agricultural consultant since 1979.

THIS YEAR'S Unified Wine and Grape Symposium (UWGS) was held at the Cal Expo rather than the Sacramento Convention Center. This allowed for, what seemed to my feet, a much larger trade show.

I didn't have a particular theme for the items I decided to list here. I'm a production winemaker, so my bias is always going to be toward winery equipment that would be found somewhere between the weigh-bridge and the shipping warehouse. I do try to take a look at the vineyard equipment

as well, but such items will always be a bit underrepresented in any list I put together.

My criteria for choosing what to include in this list is fairly simple: Does the item look like it will enable a winemaker to make better wine or to make wine more efficiently? Is it new, or at least new to me or to the UWGS? Finally, the nebulous and idiosyncratic question of "is it cool?" will always weigh heavily in my considerations.

RoboBottle

G3 Enterprises

I listed the RoboBottle last year, but there have been enough developments, including two additional RoboBottle types, over the past year, so I feel that the line warrants inclusion in this year's list as well.

WHAT IT IS: The RoboBottle from the G3 Open Innovation Lab, a division of G3 Enterprises, is a set of tools designed to aid the bottling line mechanics in setting the line for a particular bottle shape. At its core, a RoboBottle is a set of sensors and a small computer in a bottle-shaped package:

RoboBottle Set-up Bottle: As the name suggests, the Set-up Bottle is used to set up the bottling line.

RoboBottle O₂ Bottle: The RoboBottle O₂ Bottle is meant to measure the in-bottle headspace oxygen content in real time as the bottle progresses through the bottling line.

WHAT'S COOL: With its associated app, BottGuide, the G3 RoboBottle gives bottling line mechanics near real-time feedback and advice for setting-up and maintaining screw-cappers.

For more information: G3 Innovation Lab, wineiot.com/robobottle.



THE CLEAN CORK WITH A CLEAR PROMISE

Introducing ScottPlus™ Dry-Steam Natural Cork

We were the first to bring SPME testing to you and the first to use SO₂ to protect natural cork. Now, after four years of research and trials, we are proud to bring you a revolutionary process for the removal of TCA and other off-aromas. We're calling it **ScottPlus™—clean, natural cork processed and delivered at scale** with the Scott Laboratories legendary promise of quality and integrity.



LET'S TALK CLEAN >

Learn more at scottlab.com/cleancork

Sparkling tour USA 2020

BASE WINE OPTIMIZATION TECHNIQUES

Key Points For Award
Winning Sparkling
Wines

- 4/20 ▶ Southold, NY
- 4/22 ▶ Crozet, VA
- 4/23 ▶ Walla Walla, WA
- 4/27 ▶ McMinnville, OR
- 4/29 ▶ Santa Rosa, CA
- 4/30 ▶ Lodi, CA
- 5/1 ▶ Paso Robles, CA
- 5/4 ▶ Ensenada,
BC Mexico

PLEASE CONFIRM YOUR PRESENCE

cgiuffre@oenofranceusa.com
fmdg@oenofranceusa.com
Ph: 707.971.8270



STATION
OENOTECHNIQUE
DE CHAMPAGNE
www.oenotechnic.com

distributed by

OENOFRANCE
USA
www.oenofrance.com

Cool Products at the Unified Wine & Grape Symposium

Diaphragm Pump

Murzan Pumps and Processing Systems



It's always nice to see new vendors at UWGS. Murzan Pumps and Processing Systems have been around since 1983, making sanitary pumps for the food, beverage, pharmaceutical and cosmetic industries.

WHAT IT IS: Murzan pumps are air-operated diaphragm pumps that can handle anything, including the thick and viscous, like tomato paste; to shear-sensitive emulsions, like lotions and icings; delicate food-products like cottage cheese and yogurt; and even solutions containing a large amount of solids.

WHAT'S COOL: I listed Murzan because they have a proven track record in pumping a range of food products that can be even more challenging than moving must and wine.

For more information: Murzan, www.murzan.com.

TAKE YOUR WINE ANYWHERE, BECAUSE YOU CAN!



WHY CANS?

Sustainable
Convenient
Versatile

WHY CANSOURCE?

Low Minimums
Short Lead Times
Vibrant Graphics

EMAIL US TODAY OR VISIT OUR WEBSITE:
GETCANS@CANSOURCE.COM
WWW.CANSOURCE.COM

Bowpeller

McFinn Technologies

I mentioned US-FIP (AKA McFinn Technologies) and its uniquely designed flexible-impeller pump carts when the company started coming to UWGS. US-FIP/McFinn Technologies is based in Kenosha, Wisconsin, since the state is famous for its cheese and dairy products. I doubt there is any coincidence that it's also a hub for low-shear sanitary pump manufacturers.



WHAT IT IS: The Bowpeller is a low-shear, centrifugal pump with a patented impeller design.

WHAT'S COOL: The impeller is designed to pump gently with a higher resistance to cavitation than is typical for centrifugal pump designs.

For more information: McFinn Technologies, www.americanwinepump.com.

vinoPAL

Invisible Sentinel

Readers should be familiar with the vinoBRETT analysis, produced by Invisible Sentinel, which allows onsite PCR (Polymerase Chain Reaction) detection of *Brettanomyces bruxellensis*.

The vinoPAL (PAL denotes *Pediococcus* and *Lactobacillus*) is a set of similar analyses for a range of species of wine spoilage, including LAB (Lactic Acid Bacteria). Currently, the system detects 13 *Lactobacillus* and species known to occur in wine.



WHAT IT IS: Invisible Sentinel released vinoPAL as a method of *Pediococcus spp.* and *Lactobacillus spp.* detection using their Veriflow technology.

WHAT'S COOL: Early and direct measurement of viable *Lactobacillus* and *Pediococcus* species in just three hours offers a quick test to see if LAB are the cause of suspected sluggish fermentations in time for effective remedial actions to be used. The best-use scenario is to use vinoPAL preemptively to determine which fermentations are at risk from LAB and correct potential problems before they occur.

For more information: Invisible Sentinel, www.invisiblesentinel.com.

Cellar Cart

Sonoma Stainless

Sometimes it's the small things that really matter. A cellar cart may seem like a small thing compared to bottling lines, presses, optical sorters and mechanical harvesters, but having a decent fittings cart can make all the difference to a production winemaker—even though few of us would remember just how important they are until one has to work without one.



WHAT IT IS: The Cellar Cart is pretty much exactly as the name implies: It's a place to put all the fiddly bits one needs to hook up sanitary hoses and the like. I'm always on the lookout for equipment like this. It probably seems silly to say, but when you're a winemaker or a cellar worker, a well-designed fittings cart makes a huge difference in being able to keep all the Tri-Clover/tri-clamp, and other sanitary tools, off the ground so that they stay sanitized until needed.

WHAT'S COOL: Since Sonoma Stainless is a custom stainless steel fabricator, these carts can be made to fit the needs of any individual winery. I like the option for additional washing tubs.

For more information: Sonoma Stainless, sonomastainless.com.

DELLA TOFFOLA

USA

We Build The Tools You Craft the Wine



dellatoffola.us

975 Corporate Center Parkway, Ste 130
Santa Rosa, CA 95407 - USA
Phone: (707) 544-5300 | Fax: (707) 837-8742
Email: dtgroup@dellatoffola.us



JUNE 15–18, 2020
JOINT 71ST ASEV NATIONAL CONFERENCE AND 45TH ASEV EASTERN SECTION ANNUAL MEETING

Marriott Portland
 Downtown Waterfront
 Portland, Oregon USA

Registration opens in April
asev.org

Merit Award Presentation
 Dr. Hildegard Heymann
 University of California, Davis

Extension Distinction Award Presentation
 Dr. Michelle Moyer
 Washington State University, Prosser

Honorary Research Lecturer
 Dr. Hans Schultz
 Hochschule Geisenheim University, Germany

Keynote Speaker
 Gavin Sacks
 Cornell University, New York

Invasive Pests Symposium



Cool Products at the Unified Wine & Grape Symposium

Roxor

Mahindra



Mahindra, and Mahindra Ltd., is a large industrial conglomerate based in India with subsidiaries all over the world, including an assembly plant in Auburn Hills, Mich. The company licensed the Willys Jeep for manufacture in India in 1947 and have kept its Jeep derivatives in continuous production ever since.

WHAT IT IS: The Roxor (usually styled ROXOR) is a no-nonsense, off-road-only, quarter-ton light truck or utility vehicle just like the original Willys. I was going to say that the Roxor is a “no-frills: UTV,” but plenty of frills are available. They just cost extra.

WHAT'S COOL: I'll blame a childhood spent watching “Combat!” and “The Rat Patrol,” but I've always liked Willys Jeeps. I'd rather drive one than one of the other available side-by-side UTVs on the market. The Roxor maintains the Willys heritage with a box steel frame while adding important utility features like a modern 4-cylinder diesel engine and PTO output built into the rear of the transfer/transmission case. The two-stick shifter found in the original Willys has also been updated to a single-stick shifter.

WISH LIST: I wish there was a version of the Roxor that was street legal in California and without the 45 MPH speed governor. Mahindra does make a “street-legal” Willys-derived vehicle called Thar, which seems fairly popular in India, but seems to be unavailable in the U.S.

Like many ATVs and UTVs, there are after-market street-conversion kits available for the Roxor that add lighted license plate holders and some basic safety items, like horn and turn signals, but these don't appear to meet the requirements of the California DMV to the extent that, even with such kits, one would have to register the Roxor conversion in another state.

For more information: Mahindra Automotive North America,
www.roxoroffroad.com **WBM**



THE QUALITY LEADER IN MOBILE CANNING SINCE 2013

- **Proudly partnering with more wineries than ever before** - IHC is your solution to guide you through the canning process!
- **Over 100 MILLION cans filled to date, over 6 MILLION wine cans filled.**
- **Quality** – guaranteed seams, dissolved O2 measurement, in house lab capabilities.
- **Still or Sparkling & Flexible can sizes** - 187ml, 250ml and 375ml sizes!
- **Co-Packaging Partners** – whatever your situation we can get your product packaged.



Now servicing the upper Midwest in MI, IL and IN!

Materials sourcing, variety of size options, on-site filling, still and sparkling.

IRONHEARTCANNING.COM
INFO@IRONHEARTCANNING.COM



PARSEC
LEADER IN ENOLOGICAL AUTOMATION

AIR MIXING M.I.®

A new patented solution for wine cap management that has been revolutionising enology since 2014.

APHROMATE

For the most innovative and precise control in the production of sparkling wines (Charmat Method).

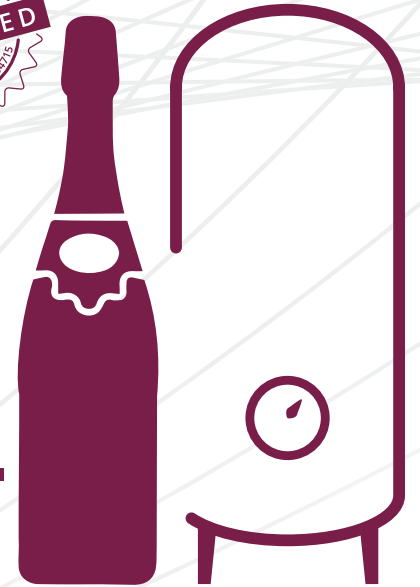

Beware of imitations

Go beyond simple industrial automation and switch to **real process control.**



SAEn5000, a single integrated multiprocessor system to best manage the enological process.



- | | | | | | | | | | |
|--------------------------------------|---|---|---|--|--|--|---|---|-------------------------------------|
| <p>TAR
mium
maker</p> | <p>EVO 2000
BUS
Precise product dosage</p> | <p>MOX
Precision
Micro O₂</p> | <p>TC
Much more than just
thermoregulation</p> | <p>ADCF
Real-time
fermentative kinetics</p> | <p>SPREADER
Pumping over for
any type of tank</p> | <p>EVO PRO
Dissolved gas
management</p> <p>O₂ CO₂</p> | <p>OXYLEVEL
Polyvalent solution for
oxygen measurement</p> | <p>DENSITY
Real-time
density</p> | <p>WIN
CLIM
Free</p> |
|--------------------------------------|---|---|---|--|--|--|---|---|-------------------------------------|

Parsec develops revolutionary and cutting edge solutions for managing vinification processes via a blend of technology, functionality and design. One system is their patented and unique **Air Mixing M.I.®**, an innovative enological method offering comprehensive and effective extraction, complete cap desegregation through liquid waves generated by an

advanced, patented design of modulated air or nitrogen injections. Then there is Parsec's **Aphromate** system, the only enological control for sparkling wine production. Both are functions of the Award-winning Multiprocessor BUS System SAEn5000. **Parsec: developing innovative and reliable solutions for winemaking since 1996.**

www.parsecsrl.net

Exclusively distributed by:



New Options in Oak Alternatives

Manufacturers Unveil Innovations at the Unified Wine & Grape Symposium Trade Show

Jim Gordon



Jim Gordon, editor at large for *Wine Business Monthly*, writes and edits articles on grape growing, winemaking and wine marketing. He has been covering wine and the wine business for more than 35 years, notably as the editor of *Wines & Vines* from 2006 through 2018. A role as contributing editor for *Wine Enthusiast* magazine began in 2014, in which he reviews California wines and reports on various California wine regions. He was executive director of the annual Symposium for Professional Wine Writers at Meadowood Napa Valley from 2008 to 2015. Dorling Kindersley (DK Books) of London published his first book as editor-in-chief, *Opus Vino*, in 2010, which was chosen as a finalist in the James Beard Awards. In 2002 he was co-creator and managing editor of the long-running Wine Country Living TV series for NBC station KNTV in San Jose/San Francisco.

MORE OPTIONS IN French oak, different dimensions in staves and new methods of toasting were some of the most interesting new features that producers of oak alternatives unveiled at the Unified Wine & Grape Symposium (Unified) this year.

For this article, we looked specifically at products and features for chips, blocks, staves, sticks, etc. (not including powders and tannins) that were

presented by manufacturers as new introductions to the North American wine industry at the Unified trade show Feb. 5-6 in Sacramento, and asked the company representatives to explain their new innovations.

Here is what we found, organized alphabetically by the brand name of the oak alternative company or division.

Arôbois Oak Blocks 47

Gusmer Enterprises

A new line of oak blocks in the Arôbois line is made from French oak that has been seasoned in the open air for more than four years, according to company representative Jean Marie Garrigue. The seasoning and toasting processes for Arôbois Oak Blocks 47 are proprietary, he said, adding that these processes remove the green tannins from the oak and make it smoother. Garrigue noted that the processes are more important than the individual oak trees that the blocks come from, which vary by forest and even individual locations.

The approximately 2-inch square blocks come in a Balance toast and an Intense toast, both of which are recommended for two to three months contact, followed by a similar period of “harmonization” after removing the blocks.

For more information:

www.gusmerwine.com/catalog/oak-blocks/arobois-oak-blocks



Fiber Infusion Barrel Alternatives

River Drive Cooperage & Millworks

Matthew Albrecht, owner of River Drive Cooperage & Millworks offers a plethora of oak-based products for the spirits and wine industries and has a new product for those wineries looking to add some spirit flavor to their wines. Using oak cubes produced by Innerstave, Albrecht infuses them with spirit flavors from bourbon, tequila, brandy and other spirits.

Carolyn Hillman at Innerstave said wineries are using the cubes for bourbon-aged red wines and the like. River Drive developed a proprietary, TTB-approved process for infusing the flavors into the oak more quickly than simple soaking. Innerstave represents River Drive for these products.

For more information:

www.riverdrive.co/barrels/natural-f-i-t-barrels and www.innerstave.com



FULLY ENGAGED FOR ANY FLAVOR



The Creative Oak team will work side-by-side with you to conjure up unique, distinctive flavor ideas, or guide your selection from our remarkable range of options. We make oak alternatives that create any flavor you envision, for every drop you craft.



CREATIVE OAK

FLAVOR FORWARD

creativeoak.com • creativeoakstore.com

Gusmer Offers a Complete Line of Oak Adjuncts!

Gusmer Oak Products

GRANULAR OAK

- American Oak Avantage®
- French Oak Avantage®
- Premium Oak-Mor®
- Toasted Oak-Mor®

OAK CHIPS

- American Oak Avantage®
- French Oak Avantage®



Arôbois Oak Products

FRENCH OAK CHIPS

- **Sweet** – caramel, vanilla, sweetness
- **Balance** – gingerbread, licorice, silky tannins
- **Fresh** – spice, enhancing length
- **Intense** – almond, cocoa, creating roundness

FRENCH OAK BLOCKS

- **Balance** – gingerbread, licorice, silky tannins
- **Intense** – almond, cocoa, creating roundness



www.gusmerwine.com
sales@gusmerenterprises.com

West Coast: 81 M Street Fresno, CA 93721 Tel: 559.485.2692	The Wine Lab™: 640-D Airport Road Napa, CA 94558 Tel: 707.224.7903	Gusmer Sonoma Store: 9025 Old Redwood Hwy, Ste E Windsor, CA 95492 Tel: 707.836.1056	East Coast: 1165 Globe Avenue Mountainside, NJ 07092 Tel: 908.301.1811	Midwest: 1401 Ware Street Waupaca, WI 54981 Tel: 715.258.5525
--	--	--	--	---

 Gusmer Videos - www.gusmerwine.com/videos    

New Options in Oak Alternatives

Boisé Inspiration Staves

Vivelys

The Boisé line of oak adjuncts from Vivelys has expanded from their traditional offerings of oak chips to a new line of staves as well. Boisé Inspiration staves come in 7 mm thickness for relatively quick extraction and 20 mm thickness to enhance volume and structure in a wine's mouthfeel over a longer contact time.



The French oak staves offer three convection-toasted profiles ranging from light vanilla with a touch of sweetness to smoky style staves that maximize structure. Cecilia Cunningham, a Vivelys USA consultant, stressed the synergy of using staves in conjunction with micro-oxygenation when maturing red wines in tanks rather than barrels. G3 Enterprises is the distributor.

For more information: www.g3enterprises.com/boise-oak-alternatives

Creative Oak French Oak Chips

Cork Supply Group

Creative Oak has added French oak chips to its lineup, sourced from forests in the center of France and Northern France and milled in France as well. Tonnellerie Ô's vice president and general manager Josh Trowbridge said that winemakers have been asking for the smaller format and elegant toast profiles of these 20-month seasoned chips to provide quick impact closely replicates a Tonnellerie Ô French barrel.



Trowbridge underlined the sustainability aspect of using the considerable parts of an oak log left over after the traditional barrel staves are cut. "It really uses the whole tree," he said.

For more information: www.creativeoak.com

Eco Impact Staves

Quercus Concepts

The company promoted its "groovy technology" that fashions oak staves from Hungarian, French and American oak in a way that looks like corduroy or the wall of a log cabin in miniature. The stated benefit of these Eco Impact staves is that it offers more surface contact compared to traditional flat staves.



They come in untoasted, medium, medium-plus and fire toast profiles.

For more information: classicoakproducts.co.nz/images/ECO_IMPACT.pdf



**FINE
NORTHERN
OAK**

★ **THE BEST OF AMERICAN OAK**

www.finenorthernoak.com • 707-307-6222 • info@finenorthernoak.com

evOAK High Proof Series Staves

Oak Solutions Group

High Proof Series is a line of tank stave and tank stave-derived products crafted for the spirits industry but is now being used by winemakers, according to Kyle Sullivan, global managing director of Oak Solutions Group. The new products are Spice Rack, Sweet Shoppe and Charred Barrel, using American oak, and Rickhouse, made from French oak.



Sullivan noted that the Charred Barrel flavor goes through a new toasting process in which the staves are exposed to direct flame, catching fire for an instant only. The products can also be ordered in various formats including cubes, infusion staves, fan systems and oak flavoring sticks. The different configurations are intended to give the distiller a range of options to either fit through the bung of a barrel or use in tanks.

For more information: www.oaksolutionsgroup.com/ev oak/high-proof

Fine Northern Oak

Seguin Moreau Napa Cooperage

Known for its American oak alternatives, Fine Northern Oak has added a new oak chip product called French Touch, which is its first offering using French oak. Marion Ghiringhelli, the oak alternatives sales manager for parent company Seguin Moreau, said 24-month seasoned oak goes through an 8 to 10 hour toast cycle that starts cold and finishes cool, giving a more “sweet” and elegant effect in the wine.



For more information: www.finenorthernoak.com/products.html

The Oak Lab Thermic Range

Scott Laboratories

One of the biggest recent innovations in oak alternative production was developed by The Oak Lab division of Scott Laboratories. The company toasts its new Thermic range of oak infusion products under vacuum conditions, resulting in a “a level of accuracy and consistency different than traditional oak infusion products that are toasted, baked or electrically radiated,” according to the company.



Cynthia Coleman, The Oak Lab’s director, formerly worked for Beringer Vineyards in the sensory lab and as a senior business manager, where one of her jobs was buying wood. She argued that heating under a vacuum works better than convection toasting and does a more complete job of heating all the way through the wood. Thermic products come in various formats, including stave fans, bung inserts, cubes and tank rods. Coleman said the Thermic process is a “world first” in terms of wine-related products.

For more information: www.theoaklab.com

INNOVATION AMPLIFIED

Crank it up to eleven.

Whether you’re looking to dial in more elegance, balance, structure or mouth feel, our oak alternatives help you fine tune your tone to rock the perfect composition.

Derived from the same oak selection as our barrels, our range of alternatives is produced to accent your artistry and respect your fruit.

Because whether you’re more classic rock or techno-pop, complexity and volume never go out of style.

CENOSTAVE® CENOCHIPS® CENOFIRST® CENOBLOCK® CENOSTICK®

INSPIRED BY THE PAST,
BUILT FOR THE FUTURE
info@seguinmoreau.com | +1.707.252.3408
seguinmoreaunapa.com

Q u e r c u s

A C U T A B O V E

S U P E R I O R O A K A L T E R N A T I V E S

P | (707) 775-7065
E | Quercusconcepts@gmail.com
www.OakAlternatives.com

FIRE TOAST STAVES



Introducing



XTRACHÊNE
MASTER COOPER SERIES

NOSE – AROMATIC PROFILE



Crafted from barrel-quality French oak that was open air-seasoned for 24 months, XtraChêne delivers complex aromatics and texture to high-end wines.

To schedule your trial, call or email.

707.843.4407 • sales@xtraoak.com • www.xtrachene.fr

Oenochips Exception

Seguin Moreau Napa Cooperage



Seguin Moreau introduced a new product in its alternatives line, Oenochips Exception, during the Unified trade show. These are untoasted French oak chips that are sold in polyester infusion bags. They are designed to quickly impart an impression of sweetness in wine and provide intense, fruity notes without blatant oakiness, according to sales manager Marion Ghiringhelli.

Another recent offering is V18 Sweet in the Oenostick line. These are chains of cylinder-shaped oak rods used as through-the-bung barrel inserts. V18 is intended to add vanilla and toasty notes to dry red wines. Ghiringhelli also touted the company's Oenofinisher product, which is made of oak chips that come in the form of compressed bricks in infusion bags. These are designed for short, one- to three-week treatments, using a combination of French and American oak.

For more information: www.seguinmoreaunapa.com/product-details

Tonnellerie Sirugue

Nuits Saint Georges, France

Natural Air-drying French Oak



Exclusive U.S. agent:
Françoise Gouges
3435 Ocean Park Blvd, #107-511
Santa Monica CA 90405
Cell: 310-403-8398 • Email: francoise@sirugueusa.com • www.sirugueusa.com

Phenese Tank Staves and Chips

G3 Enterprises



G3 Enterprises introduced an expansion of its Phenese line of oak staves and chips to winemakers at the Unified Wine & Grape Symposium. The 36-inch tank staves are cut to the unusual thickness of 11 mm to allow for a four to five month contact with wine, and come in two contrasting toast levels, each produced in a long convection toasting cycle that penetrates the whole stave. Phenese chips come in an all-French oak version called Phenese Tradition, and the Phenese Lush Blend of French and American oak.

For more information: www.g3enterprises.com/phenese-oak-alternatives

CREATING A CULTURE OF CLEAN™



"We can do it all..."

- Bottling Lines
- Barrels
- Tanks
- Floors and Walls
- Winery Equipment
- Vineyard Equipment

High Pressure Barrel Washer

- Integrated suction system for wash water
- Dual axial, 360° rotational spray head
- Bunghole up washing
- HD models with patented water hydraulic motor
- For barrels with bunghole >37 mm (1.45" Dia.
- For use with pressure washer (min. 1450psi, 3.4gpm)
- All wetted surfaces of stainless steel



(800) 735-9277

Swash Sanitizing Equipment • www.swashequipment.com
info@arsenterprises.com • (800) 735-9277



Pronektar Barrel Stick Sets

Tonnellerie Radoux

Barrel Stick Sets were Pronektar's major introduction at the trade show. These through-the-bunghole products come in 17 mm thickness based on the company's staves, giving them "greater complexity and more integrated oak" effects than the 7 mm product previously offered, according to Pronektar sales manager Steve Burch. Toasted in a convection oven, they are formatted in sets of three sticks, each 13 inches long. A set gives the equivalent of 12.5 percent new barrel treatment and are typically used for six to eight months, he said.



For more information:

www.tonnellerieradoux.com/pronektar/oak-adjuncts

XtraChéne Fire Toast Staves

Canton Cooperage

XtraChéne, the oak alternatives division of Canton Cooperage, was touting its Master Cooper Fire Toast staves made in France from French oak, as well as chips sourced from both American and French forests. The staves are made from oak wood that was open-air seasoned for a minimum of 24 months before toasting over an open-flame oak fire in a process they say is "akin" to barrel toasting. Designed for high-end wines using progressive extraction, they add complex aromas and length, said Katie Mattas, area sales manager.

The new line of chips dubbed XtraMocha puts French and American oak together in processing, so one product promises the structure, length and spiciness of French wood with the roundness and caramel notes of American wood. XtraChéne recommends using these staves for post-alcohol fermentation, at 15 to 40 pounds per 1,000 gallons.

For more information: www.xtrachene.fr/index.php/us

WBM



Welcome to the deep end.

The Canton Five imparts luxurious depth, texture and complexity to high-end wines while preserving the fresh character of your fruit.

5 YEAR OPEN AIR-SEASONED WOOD
Limited Production: 225L only
with proprietary Canton Five toast

707.843.4407 • Toll Free: 877.542.1158 (within USA)
www.cantoncooperage.com

**UNIQUE WINE RECIPES
DESERVE QUALITY
SELECT INGREDIENTS**

bsgwine.com | 800.585.5562
474 Technology Way, Napa CA 94558

Technical Spotlight: Aperture Cellars

Winemaker Jesse Katz designs custom winery with a “no holds barred” approach to producing premium quality wine

Stacy Briscoe



ANDY KATZ

Rockpile Ridge Vineyard, Lake Sonoma

“**HOW I GOT INTRODUCED** to wine was through food and through travel and through art,” said Jesse Katz, owner and winemaker for the newly developed Aperture Cellars. Katz is the son of Andy Katz, a well-known photographer whose portfolio spans wine regions all over the globe. Like his father’s photography, Jesse Katz’s winemaking education took him around the world. His résumé includes experience at well-known winemaking estates, including Pétrus in Bordeaux, Bodega Noemia in Argentina and Screaming Eagle in Napa.

But Katz has always wanted to design his own estate winery—a dream achieved in fall 2019 when he and his team celebrated their first vintage in a newly constructed production facility located just off Old Redwood Highway in Healdsburg, Calif.

Katz said his priority was, and is, always wine quality. “I had a no holds barred approach for implementing the level of detail to create the style of wines I want to,” he said. “This is the third winery I’ve designed, the fifth that I’ve been a part of the construction. But this is the first time I’ve been able to design and build what *I* wanted. This is my dream.”



Stacy Briscoe is the assistant editor of *Wine Business Monthly*. Previously, she was a freelance wine writer for multiple publications, including the *San Francisco Chronicle*, *Napa Sonoma Magazine*, *Edible Silicon Valley*, among others. Stacy has a Bachelor of Arts degree in English-language literature, holds a WSET Level II certificate and is continuing with the WSET program. Outside of wine writing, she’s also a contributing editor for independent publisher She Writes Press/Spark Press.

New Estate, New Plantings

Katz purchased his 32-acre estate from the Ponzo family in 2016. At the time, the property included 30 acres of planted vines and three buildings. Katz decided to keep just one of those buildings, which he renovated into his new home, clearing the other two to make space for his estate winery.

During the time-consuming permitting process, Katz and his team made wine from every single block on the property to see what level of quality the existing vines could produce. “The two blocks that were standouts, by far, were the ones planted in 1912,” Katz said, referring to the old vine Zinfandel that line the blocks closest to the new winery.

The other blocks, he said, could not achieve the quality of wine he’s looking for. “The old vine stuff we kept, but there were 20- to 30-year-old vines here that had some viruses and were set up in a weird row orientation, not well set up for sun exposure. And they were really low-density,” Katz said. “The acreage of vineyards, since we bought the land, hasn’t changed much, but the amount of vines has pretty much doubled.”



The Nose Knows

Aroma is critical; we get it.

Which is exactly why we had Alexandre Schmitt, aka the Nose of Bordeaux, evaluate in a blind test MASilva natural corks processed with SARA ADVANCED®; innovation that eliminates off aromas and results in neutrality.

Watch the reveal at masilva.com/TheNose

Request your SARA ADVANCED® Natural Cork Sample
info@masilva.com | 707.636.2530



MASILVA USA
THE PERFECT FIT FOR YOUR WINE

Aperture

12291 Old Redwood Hwy, Healdsburg, CA 95448 | aperture-cellars.com | 707-200-7891

OWNERS/PRINCIPALS

Jesse Katz, winemaker/owner

Hillary Sjolund, associate winemaker

Phil Freese, vineyard consultant

WINERY INFORMATION

Year Bonded 2019

Winery Case Production

- 65K approval of case production per year
- Winery with current set up ~40K cases/year
- ~30K cases produced in 2019 under all clients
- ~12K cases under Aperture Cellars label

Average Bottle Price \$70

Direct-to-Consumer Sales 77%

VINEYARD INFORMATION

Appellation Russian River

Vineyard Acreage (estate) 32

Varieties Grown (estate) Semillon, Sauvignon Musqué, Cab Sauvignon, Merlot, Malbec, Zinfandel, Petit Sirah

Sustainability Certification In progress

Sustainability Practices Yes, no glyphosate, and minimal Sulfur

Soil Type 9 different types including Blue Clay and Volcanic gravel

Other vineyard property

- Oliver Ranch, Alexander Valley
- Del Rio, Alexander Valley
- SJ Ranch, Alexander Valley

Varieties Grown Cabernet Sauvignon and Malebc

Sustainability Certification(s) Same

Sustainability Practices Same

Tons Used vs. Tons Sold (estate grapes) 90% used, 10% sold (estimate for future acreage)

Additional Varieties Purchased Chenin Blanc, Cabernet Sauvignon, Cabernet Franc, Merlot, Malbec, Sauvignon Blanc

Vineyard Sourcing

- Rockpile Ridge, Farrow Ranch, Del Rio, Warnecke, Dry Stack, Kick Ranch

BUILDING THE WINERY (Production Facility)

Year Built 2019

Size 21,379 square feet

Architect Signum Architecture, www.signumarchitecture.com

Contractor Grassi and Associates Inc. www.grassiandassociates.com

Interior Design H. Palmer Design, www.hpalmerdesign.com

Landscape Architect Frank + Grossman Landscape Contractors, Inc., frankandgrossman.com

HVAC Henry Mechanical, www.henrymechanical.com

Cellar Humidity Control Smart Fog, www.smartfog.com

Wastewater System Cloacina, Inc., www.cloacina.com

WINEMAKING

Wines Made Cabernet Sauvignon, Malbec, Bordeaux-style red blends, Sauvignon Blanc, Chenin Blanc

Receiving Hopper Bucher Vaslin, www.bvnorthamerica.com

Vibrating Sorting Table Bucher-Vaslin Delta TRV 25 vibrating sorting table, www.bvnorthamerica.com

Iso-Flo Vibratory Conveyer, Key Technologies, www.key.net

Weco optical sorter with WineGrapetTek Color Sorter, wecotek.com

Destemmer Bucher Vaslin Oscillys 200 destemmer, Bucher Vaslin TR300 elevator, www.bvnorthamerica.com

Tanks Sliver State Stainless, silverstatestainless.com

Tank Heating/Chilling Systems TankNet, Acrolon Technologies, Inc., www.acrolon.com

Punchdown Devices manual

Pumpover Devices Carlsen & Associates, carlsenassociates.com

Pumps Carlsen & Associates, carlsenassociates.com

Racking Wands Carlsen & Associates, carlsenassociates.com

Hoses Carlsen & Associates, carlsenassociates.com

Press Prexa F40 pneumatic press, Puleo, www.puleoitalia.com

Forklift Toyota

Bin Dumper Cascade forward bin dumper, www.cascorp.com

Barrels 100% French Oak

Barrel Washing System Steam

Winemaking Management System TankNet, Acrolon Technologies, Inc., www.acrolon.com

Winemaking Software Vintrace, www.winery-software.com

Analytical Equipment Anton Paar, www.anton-paar.com

Other Key Winemaking Equipment

- Ragazzini Rotho Peristaltic must pump, www.peristaltic-pumps-ragazzini.com

PACKAGING

Bottling Line Mobile

Glass M.A. Silva, www.masilva.com
Saxco, www.saxco.com

Corks Diam, www.diam-closures.com

Capsules Amcor, www.amcor.com

Label Design Chuck House, lcondesigngroup.net

Label Printing CCL Label Industries, ccllabel.com

Case Goods Storage Alexander Valley Cellars, LLC, alexandervalleycellars.com



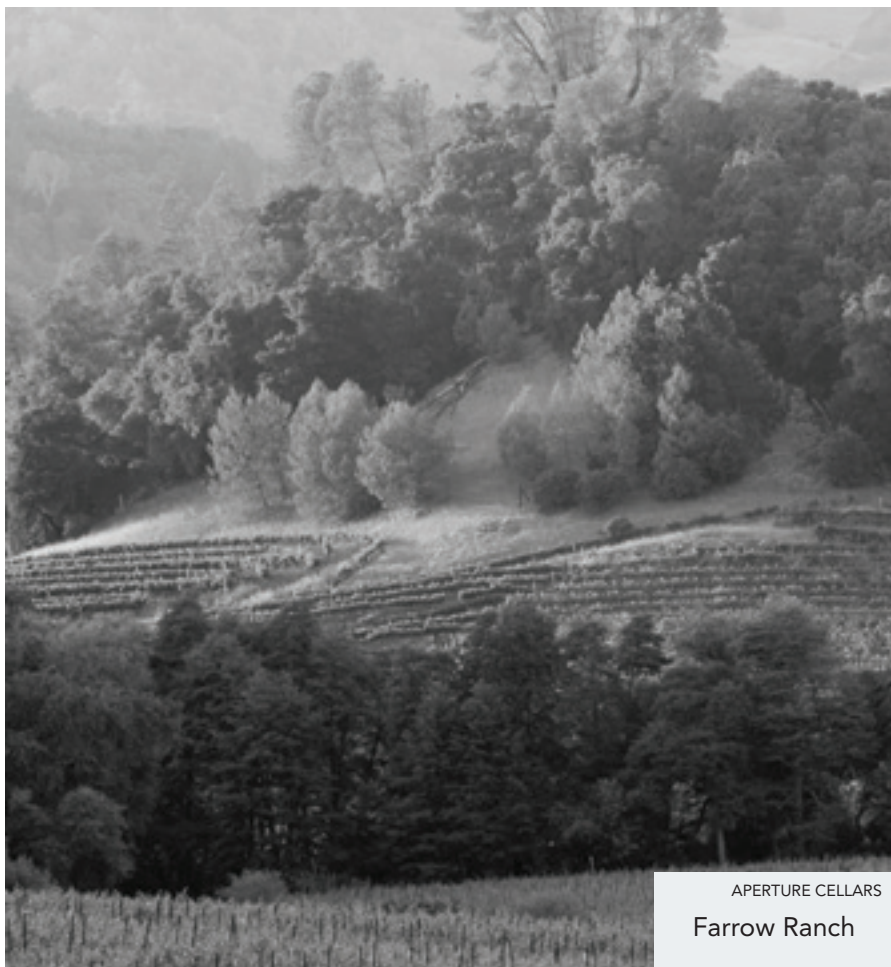

APERTURE CELLARS
Farrow Ranch

As part of his due diligence, Katz had Paul Anamosa, a soil scientist, viticulturist and owner of Vineyard Soil Technologies, dig 56 different soil pits within the 30 acres to see how best to redevelop the vineyard. “He came back with something like a 140-page soil dialogue and a 3D mapping of the water-holding capacity, organic material and all the nutrients,” Katz said.

Anamosa found that Katz’s new estate is home to nine different soil types. The acreage closest to Old Redwood Highway contains gravelly, volcanic soils; beyond that, there is blue clay, which Katz compares to the soils found at Pétrus. The soil gradient keeps softening from there, with the blocks furthest east consisting of heavy clays that soak up rain like a sponge and, after more abundant showers, even pool water above the surface.

The range of soils is perfect for Katz, whose sole focus is Bordeaux varieties, including Cabernet Sauvignon, Merlot, Malbec, Sauvignon Blanc Musqué and Semillon, in addition to the old vine Zinfandel. Katz believes these varieties thrive in the proper soil type.

“In my opinion, one of the faults of the California wine industry is that we blanket-plant to what’s popular in that region,” he said. “We’re in the Russian River Valley, so most people would have purchased this property and planted to Pinot Noir or Chardonnay because you can get a really high price per ton for those varieties.” To Katz, the soils dictate otherwise.

With knowledge and data to back him up, Katz, with the assistance of Anamosa and viticulturists Phil Freese and James Stamp, implemented thoughtful, purposeful planting for each grape variety and clone newly rooted into his vineyard. In the spirit of viticultural name-dropping, some of those new vines include Semillon cuttings from Château d’Yquem and Merlot clones from Château Pétrus.

Outside of his newly acquired estate vineyard, Katz also has long-term leases at vineyards throughout Alexander Valley and sources grapes from vineyards he’s worked with for many years. “Every piece of viticulture we control,” said Katz when asked about his involvement in the outsourced vineyards. “The same crew that works our estate vineyard [Tri Valley Vineyard Management] works our leased vineyards.”

SUSTAINABLE ALTERNATIVE PACKAGING SOLUTIONS FOR WINE-ON-TAP & WINE-IN-A-CAN

Let your wine shine!



FREE



FLOW

QUALITY FOCUSED & WINE SPECIFIC

KEG LEASING, FILLING & LOGISTICS SERVICES

100% REUSABLE STAINLESS STEEL KEGS

COMPLETE WINE CANNING

WWW.FREEFLOWWINES.COM

415.626.1215

New Winery, New Winemaking Tools

Inside the new winery, Katz invested in some of the newest, highest quality winemaking equipment on the market. “We spend most of our time in the vineyard so when the grapes come in, it’s all about finding the purest expression of that fruit,” Katz said.

After harvest, the fruit is delivered to the large outdoor crushpad in the center of his winemaking facility. Any fruit that’s not ready for processing will be stored in a cold room that can stash about 20 tons of grapes and is kept at a steady 50° F.

Both red and white grapes will go through a Bucher-Vaslin receiving hopper and onto a Delta TRV 25 vibrating sorting table. The sorting table feeds directly onto the incline conveyor, which then moves fruit into the destemmer, and Katz said the table does a better job than any other sorter he’s used to pick out shot berries and raisins. Additionally, and most importantly for Katz, the trapezoidal grates allow for better evacuation of juices, which are then collected in an exterior tray. This component is especially critical for Katz’s white wine program. “It’s not an issue with Cabs but ... with Sauvignon Blanc, Semillon or Chenin, that de-juicing is critical,” he explained. “There was one lot we decided to get rid of altogether just because the volatile acidity was so high and the quality of the grape wasn’t there. So, we have that extra sorting element in place.”

After sorting, the red grapes are fed into a Bucher-Vaslin Oscillys 200 destemmer via a Delta 300 incline conveyor. The Oscillys 200 is what Katz refers to as a “double barrel system,” as the machine has two separate cages for destemming the fruit, ensuring that all stems are entirely removed from the grapes.



The best quality tanks!

- » Variable capacity tank
- » Versatile in use
- » Version with floating lid, cooling jacket and mash door available
- » Capacity from 300 to 25,000 litres
- » Precise workmanship
- » Perfect, sanitary surfaces
- » Simple handling
- » Easy cleaning
- » Made in Germany

speidel-edelstahlbehaelter.de



APERTURE CELLARS

“We don’t do any stem inclusion or whole cluster,” Katz said. “For us, we’re trying to get our tannins and the soul of the wine from the skins. We’re working with Bordeaux varieties, so that’s not really a problem. But also, stem inclusion would increase pH and drop out acidity, and we really want to showcase acidity.”

Another key component to the machine is that it acts as another sorter. “The Oscillys is really cool because you can really dial in how hard it’s shaking. And that bond with the raisins is a lot stronger than with the grapes, so it does a really good job of separating out the raisins as well,” Katz said.

The berries from the destemmer then move on to an Iso-Flo Vibratory Conveyor by Key Technologies. The slow oscillating table sorts out any leftover shot berries or raisins. Before this meticulous sorting, Katz would have to either discard the clusters altogether, because he didn’t have a way of cleanly separating good berries from dried ones, or would “deal with it,” which would result in higher Brix soak-ups.

The Iso-Flo feeds the grapes into the last level of sorting, a Weco optical sorter with WineGrape Tek. The WineGrape Tek takes a photo of every berry that passes through, then uses air pressure to shoot out any grapes that don’t meet the set parameters. “You dial in with the computer what variety you’re working with, and it has parameters of color, size and shape,” Katz explained. “And you can fine-tune those parameters. So, for example, if you think something got hurt from that heat spike, you can increase its sensitivity to raisins.”

Because of the many levels of sorting, Katz said he sees a lot less Brix soak-up in tank than before. “Usually with Bordeaux varieties, especially Cabernet Sauvignon, you’ll see about 2° or 2.5° Brix soak-up in tank. We’re seeing much lower—usually just half a degree or so,” he said. The result: a lower alcoholic conversion.

When asked if low alcohol was an important factor for him, Katz said he’s not necessarily worried about making wines high in alcohol. “I’m making



NADALIÉ
USA

COOPERAGE *is* OUR CRAFT

EST. 1980 TD
NAPA VALLEY



FIVE GENERATIONS



NADALIÉ
TONNELLERIE



TONNELLERIE
MARSANNAY
Bourgogne



707 942 9301 | INFO@NADALIE.COM | NADALIE.COM

**Want to save time, money, water and labor costs?
Our fixed base pump system is your answer.**

Pump overs at the push of a button
or set a timer and walk away - really!
It might sound too good to be true, but the technology is here.



- No crew down time
- One person supervising multiple pump overs
- No more sanitizing pump over set ups everyday
- Pump over when you want to
- The fixed base set ups work on Sundays and don't call in sick!
- No more worrying about cross fermentations or cellar blends

Call us for a quote!
Give us your tank diameters and flow requirements



1439 Grove Street, Healdsburg CA 95448
707-431-2000 ~ www.carlsenassociates.com



APERTURE CELLARS

big, layered Bordeaux-style wines," he said. The point, he explained, is about creating wines with balance and respecting all the work he and his crew have already done in the vineyard. "It gives us a lot more flexibility with extraction and as to when we pick in the vineyard. I can pick when it's ripe, when flavors are where we want them and not have to worry about a sugar increase or off-flavors or aromas because of raisin inclusion."

Next, Katz uses a Ragazzini Rotho peristaltic must pump to delicately transfer the must into tank. "This is probably the most gentle way you can move must. It's the same system they use in fish farms to move live fish from pond to pond," Katz said. The tank room is outfitted with a must line that wraps around the gantries just above the tanks. The pump feeds the must into the line, and from there it can be dropped into any one of the 27 stainless steel closed-top tanks. "And when we're feeding it into the top there, it crushes maybe 15 to 20 percent of the berries—because there's still so many whole berries in there—so it's about as gentle and as close to gravity as I've ever seen," he said.

Automatic Pump-overs Save Time—and the 2019 Vintage

Aperture Cellars' stainless steel tanks range from 5.5-ton tanks, utilized for their single-vineyard designated wines, to 12.5-ton tanks. "We designed it so that with the largest tanks, we can fit the entire pomace capacity into our press," noted Aperture's associate winemaker, Hillary Sjolund.

But the most exciting tank feature for the winemaking crew: each of the 27 tanks is outfitted with its own automatic pump-over system designed by Carlsen & Associates, complete with a TankNet management system.

This is both Katz and Sjolund's first time using automatic pump-overs. With the new system, they had to adjust their extraction protocol, and they both agree it's for the better. "For a normal extraction routine, fermenting for about three weeks, we'd pump over maybe 30 times at maximum," Katz said. With the automatic pump-over system, Katz and Sjolund were able to average 100 pump-overs per batch during the course of the red wine fermentations.

TomBeard 
C O M P A N Y

25% - 50% WATER SAVINGS

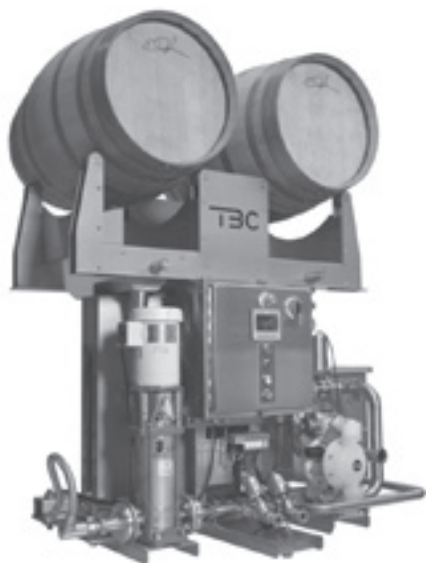

• **TBC Barrel Washer –**
*Saves 50% water over manual
spray ball use.
Current Financing Available.*

• **TBC Recycling System
Retrofit & Heat Exchanger –**
*Replaces one rinse cycle and
adjusts wash cycle for savings
of nearly 50% water use.*

• **TBC High Pressure Pump
Upgrade –**
*(For machines 2004 and older)
Upgraded system creates low
volume / high pressure water
and saves 25% water use.*

CALL TODAY for a consultation
707-573-3150 www.tombeard.com



The result is that the winemaking team is able to conduct pump-overs more often and at a much more even pace instead of “squeezing in what you can get when you can get it.” What Katz and Sjolund found was that even during cold soak and well before alcoholic fermentation, they were able to achieve wines with richer hues, more concentration and an overall more successful homogenization of aromas, flavors and textures.

Each tank has its own custom screen that encompasses all racking valves and catches all seeds and skins that sink to the bottom during that initial cold soak. “When we first bring it in, we pump over once every hour for just a few minutes. You can’t do long pump-overs because it will start clogging the screen,” Katz explained. Once a cap is formed, that’s when he can start pumping over more frequently and for longer, as well as begin incorporating air.

Katz and Sjolund use a Venturi air injector fitted to the top of the tanks, a device that pulls in air to push the wine being pumped from the bottom of the tank over the cap. “With the closed system, we don’t have sump and screen ability, so this is how we get the air to control the speed and the health of the ferment,” Sjolund said. As the wine is pushed over the cap, the dual-valve device rotates, providing even distribution throughout. “The width between the two valves is adjustable. So, we can fine-tune how much contact we want with the cap. That was a huge technological advance for us,” Sjolund said.

Every tank is hooked up to a TankNet control system so Sjolund and Katz can control every part of the fermentation process remotely—from heating and cooling the glycol jackets to fine-tuning the extraction process. Katz noted that because of this remote-controlled automatic pump-over system, Aperture Cellars was able to continue fermentation protocols through the 2019 Kincade Fire. “We turned on the generator before we evacuated. ... We never missed a beat,” Katz said.



APERTURE CELLARS

GROUPE VICARD

.....
95TH 1925-2020
ANNIVERSARY

“ Excellence is an art won by training and habituation. We do not act rightly because we have virtue or excellence, but we rather have those because we have acted rightly. We are what we repeatedly do. **Excellence, then, is not an act but a habit.** ”

- ARISTOTLE



WWW.GROUPE-VICARD.COM



When it comes to wine quality, the automated system provides Katz the ability to develop the texture of his wines during the fermentation process, which he says is what gives his wines the richness, depth and layers one would expect from big Bordeaux-style blends—without the astringency or grittiness of tannins. “Once the wine starts getting dry, you have more alcohol and more things that are soluble that you have to worry about. So, at that point, we just kind of guide it, taste two to three times a day, and pull back pump-overs to maybe just four or five times a day, just to wet the cap,” he explained.

“Because we’re able to develop the texture during the fermentation process, we can get a mid-palate shift in the wine; it becomes very full and luscious,” Sjolund added. “A lot of people use oak as their finishing tannin and to add that extra bit of richness. We don’t have to do that because we’ve already achieved what we wanted. We can see the whole wine just by looking at the extraction program. To adjust the wine, we fine-tune the ferment.” It’s because of the automated system that Sjolund and Katz are able to make those adjustments as needed during that process, simply by changing pump-over speed and/or frequency.

White Wine, Too

When it comes to the white wines, the grapes go through the initial receiving hopper, are cluster-sorted and de-juiced, then whole-cluster-pressed in a Puleo Prexa F40 pneumatic press.

Although the press has the option to conduct automatic, pre-set press fractions, Katz said that, more often than not, he and his team utilize the manual option to keep those fractions as precise as possible. “Every time we increase the pressure, we check the pH of the wine. When we start to see the pH increase and the acid drop out, we’ll separate that juice off and hold it in a separate tank,” Katz explained. For every white lot there will be two presses—a light and a heavy—and each will ferment in a separate tank. The lighter press is typically what is used in Aperture’s higher-tier white wines. The rest is either incorporated into a Bordeaux-style white wine blend or sold off, according to Katz.

“Once we’ve lost about a third of the sugar, we’ll start barreling down. At that point it’s usually around 18° or 19° Brix,” Katz said. He gives the white wine one more blast of air, taking it through sump and screen and actively splashing the wine around. “The extra oxygen provides nutrients to the yeast, but also varieties like Sauvignon Blanc and Chenin Blanc can be quite reductive, so this helps with that,” he said.

From there, the whites then move to barrel where they’ll stay until ready to bottle.

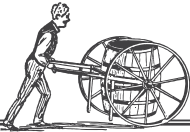





BOUCHARD COOPERAGES

A commitment to quality and customer service.



CANADELL







Premium French Oak fire & convection toasted Fans, Barrel Inserts, Dominos & Chips

*Aqueous

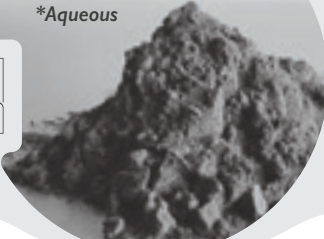
CHÊNE-oologie

FRENCH OAK TANNIN



Excellence Tannin



TOASTED
French Oak Tannin



Structure Tannin



UNTOASTED
French Oak Tannin

Also available from Bouchard Cooperages



WWW.BOUCHARDCOOPERAGES.COM
sales@bouchardcooperages.com / (707) 257-3582

WINE BUSINESS MONTHLY

The leading producer of wine industry information and events

Now Incorporating **WINES&VINES**

winemaker of the month

Holly Turner, winemaker, Three Rivers Winery, Walla Walla, WA

“Wine Business Monthly is a must-read for me. It’s the all-in-one easiest and most comprehensive way to keep in touch with industry innovations from machinery to must! I have gleaned some great insight by reading the “Varietal Focus” series, most recently the focus on Sauvignon Blanc (January 2017). We have been working on trials with yeast, oak and acidity regarding our Sauvignon Blanc really trying to bring some creaminess to the mid-palate and increasing the ripeness to the aromatics by adjusting fermentation temperatures and use of neutral oak with varying sur lie stirring and aging. By reading *WBM* I can find opinions and insights that can potentially improve our processes.”



Subscribe today visit subs.winebusiness.com or call 800-895-9463



APERTURE CELLARS

Bordeaux Barrels

White wines age for as little as six months for the lighter, more aromatic varieties and as long as a year for the Semillon and some of the richer, Bordeaux-style blends. All white wines will see at least some oak influence: Chenin Blanc typically ages in 50 percent stainless steel barrels and 50 percent used oak barrels; the Sauvignon Blanc is typically split evenly with one-third each new, once used and neutral oak barrels.

Red wines, depending on the variety, will see anywhere between 33 and 100 percent new French oak, and age between 16 to 24 months.

Katz said that the barrels at Aperture Cellars are custom, proprietary barrels. “We work with a lot of cooperages in Bordeaux that do specific toasts just for us,” he said. “What I look for is minimal oak impact, more spice-influence than that vanilla or caramel sweetness.”

Another interesting feature to Katz’s barrels is that they are 22 millimeters in thickness, as opposed to the standard 27 millimeters, providing more oxygen influence throughout the aging process. “In our red wines, especially for the first couple of years—and the first year, in particular—we don’t mind oxygen as long as we’re controlling it. In that first year, during the racking period, we’ll actually splash some of it through sump and screen, put it into tank, adjust a bit and then put it back to barrel,” Katz said. The following year, he looks for more reductive qualities, so he typically stops the racking routine, letting the barrels take over a more micro-oxygenation process.

All wines are bottled on-site using a few different mobile bottling services. Labels are courtesy of Katz’s father—all images captured throughout his illustrious career. Some, like the Bordeaux Red Blend label, which features the toasting process of the custom Bordeaux barrels, are a literal wine connection. Others are more artistic interpretations of the wine inside. [WBM](#)

EUROPEAN CRAFTSMANSHIP STAINLESS STEEL WINERY TANKS

IN STOCK, READY TO SHIP

NOW



Harvest is on the horizon. You need tanks and you need them now, but compromising on quality to get them fast is not how great wines are made.

We’re ready. Our Letina stainless tanks – jacketed, single wall, variable, you name it – are built in Europe and in stock in our Pacific Northwest warehouse, ready to ship.

Want more info? Call us today, or visit: agertank.com

(503) 222-7079

AGER TANK & EQUIPMENT CO.

AGERTANK.COM



MetLife Investment Management

Agricultural Finance



Custom Structured Agricultural Loans

- Agricultural real estate lender for more than 100 years
- Intermediate and long-term fixed or adjustable-rate mortgage financing
- Real estate secured revolving line of credit

Rates are attractive—contact us today.

559.435.0206 | www.metlife.com/ag

This document is solely for informational purposes and does not constitute an advertisement of any investment advisory services, securities or investments.

© 2020 MetLife Services and Solutions

Must Keep Pumping Must

What type of pump is needed?

Curtis Phillips



Curtis Phillips, an editor for *Wine Business Monthly* since 2000, is a graduate of UC Davis, and has been a winemaker since 1984 and an agricultural consultant since 1979.

I'M OFTEN ASKED WHICH pumps are best for moving must. This includes moving must from the receiving hopper, moving it from the destemmer, pumping wine over during fermentation and moving must from the fermenter to the press at the end of that fermentation. The primary requirements for moving must are to be able to move liquid that contains a high percentage of solids gently enough that destemmed, but otherwise intact, berries remain undamaged by being pumped. I've used pretty much every pump type described here, except the rotary piston and the helicoidal pumps, to move must at one point or the other in my career.

We Have a Directory for That, You Know

I am going to talk about pump types, but for the most part I am going to refrain from listing pump manufacturers and vendors. Instead, I want to direct readers to our nifty online product and vendor database, which can be found at winesvinesanalytics.com/buyersguide.

Progressive Cavity Pumps

When most U.S. winemakers say, “must pump,” what they mean is “screw-fed progressive cavity pump with a hopper.” Although progressive cavity must pumps are frequently fed by an Archimedes screw, the actual pump is not an Archimedes screw but a helical rotor inside of a helical cavity. As the rotor turns a void, specifically in the shape of a helical annulus, it moves along the cavity, thus displacing the wine forward. The result is a pump that can move solutions with very high solids content very gently.

Progressive cavity pumps are known by a fair number of synonyms, including progressing cavity pumps, Moineau pumps, mono pumps, moyno pumps and delta pumps. These last three are all brand names of specific manufacturers and thus “should” be capitalized as Mono pump, Moyno pump and Delta pump—but the names are used even when the pump is from a different producer.

In the U.S., these pumps are usually permanently fitted with a feed-hopper and screw-feed and are used as portable must pumps. As must pumps,

progressive cavity pumps are themselves fairly gentle and, as such, minimize further maceration of the must during transfer.

Unfortunately, the same can't be said for the pump's necessary feed auger, which can chew up any clusters and intact berries if the feed timing isn't set correctly.

Peristaltic Pumps

Peristaltic pumps work on the “squeeze-the-tube” principle most of us use every morning. Outside the winery, the peristaltic pump design is used to transfer extremely fragile fluids, like blood. They are marketed as being able to replace any positive displacement type pump (i.e., any progressive cavity, lobe or piston pump) in essentially any winery operation. Since the mechanical parts of the pump never touch the must/wine/lees, peristaltic pumps are resistant to abrasives like bentonite—an apparent advantage they have over progressive cavity and lobe pumps. They can also run dry, unlike flexible impeller pumps, and offer capacities of up to 20,000 gallons per hour.

Rotary Lobe Pumps

Rotary lobe pumps are extremely common in the U.S. wine industry. Internally, rotary lobe pumps consist of two intermeshed rotors. The fluid enters the side of the cavity and is swept along the outside of the cavity in the gaps between the lobes on each rotor. These gaps disappear as the lobes intermesh, at which point the fluid is expelled from the pump.

Lobe pumps are very versatile. They can be used for must, wine and lees transfers. Very small wineries tend to prefer the less-expensive flexible impeller pump, but essentially every U.S. winery above a certain size has at least one. I would recommend that wineries only consider 4-inch and larger diameter rotary lobe pumps to move must from the destemmer to the fermenter. For pump-overs, though, one probably could use a 3-inch diameter rotary lobe pump and be just fine. I would not, however, recommend even attempting to move whole-cluster grapes with a rotary lobe pump.

SMART • SUSTAINABLE • SIMPLE



PakTech has Repurposed over 450 Million Milk Jugs into Packaging Handles



SMART

*Attractive & Innovative. Value Added.
Smart Form & Function. Cost Effective.*



SUSTAINABLE

*Made from 100% Post-Consumer Content.
Repurposed from Milk Jugs. Recyclable.*



SIMPLE

*Easy to Carry, Remove & Apply. Grab & Go.
Highlight Brand with Color Accent Handles.*



Handle
Applicators



View all of our Handles & Applicators at
www.PakTech-opi.com // 541.461.5000

Flexible Impeller Pumps

Flexible impeller pumps are widely available and are one of the most common types of pumps found in U.S. wineries. They cannot move solids, however, unless those solids are pretty big. I usually recommend that they only be used to move juice or wine, unless the pump has a bore of 3 inches or more. Low-revolution, large-bore, flexible impeller pumps *can* be used to move must (or even viscous liquids, like honey). In these larger sized bores, flexible impeller pumps are used for permanently installed automated pump-over setups.

Flexible impellers should never be allowed to run dry, as this will cause the impeller to overheat. This, in turn, will degrade the pump, and a distinct burnt rubber flavor may be imparted to any wine or must that subsequently passes through that impeller.

Elliptical Lobe Pumps

Elliptical lobe pumps (also referred to as elliptical rotor pumps) are rare in the U.S. but are pretty common in Italy. They are meant only for moving pomace and must. These pumps operate at a fairly low rotation rate, but the relatively large size of the pump cavity keeps the must/pomace moving through the pump at a reasonable rate.

To my mind, the main drawback of the elliptical rotor design would be that the combination of the screw-feed and rotor could produce a substantial amount of shear. However, this is completely irrelevant, when moving pomace, since, unless one is making grappa, pomace is just a byproduct of wine production; the wine has already been removed at the press stage.

Helicoidal Pumps

Unlike the other pumps listed here, helicoidal pumps are not positive displacement pumps but are a special type of centrifugal pump. Centrifugal pumps work on a different principle than positive displacement pumps. In centrifugal pumps, an impeller spins in an annulus-shaped (doughnut-shaped) cavity. The rotational energy of the spinning impeller is translated into linear energy, thus movement, of the fluid in a pipe, hose or tube along the tangent of the spinning impeller. The difference between helicoidal and a more conventional centrifugal pump is in the impeller and pump cavity shapes. The cavity on a helicoidal pump is a truncated cone while the impeller is, as one might expect, helicoidal, or shaped somewhat like a conical screw. This combination does a better job of imparting the rotational velocity of the impeller into the pumped solution with less risk of cavitation than the conventional disk impeller found in most centrifugal pumps.

There are a few helicoidal pump manufacturers worldwide, albeit most of those I know about are not available in the U.S. I'm listing them here because the category is small in number and relatively new. Inoxpa probably has the best U.S. representation and has a U.S. subsidiary located in Santa Rosa, Calif. Inoxpa pumps are also sold by Scott Laboratories.



PROSPERO
Since 1972

**Providing Solutions for
All Your Wine Processing
and Packaging Needs.**

prosperoequipment.com
1-800-953-3736 info@prosperoequipment.com [f](#) [in](#) [@](#) [▶](#)

Piston Pumps

Piston pumps used to be fairly common in the U.S. wine industry. I came across the remains of a 19th century, belt-driven piston pump that was used at a now derelict winery in Kenwood just last weekend. Static versions of these pumps are still used as must pumps. Mobile units are rarely used as must pumps anymore. However, a lot of larger wineries have mobile piston pumps to move lees for settling and filtration, which can be pressed into service as must pumps, provided that an appropriate feed-hopper is also available. Piston pumps *can* be used for wine transfers and filtrations, but this is not the norm in the U.S. wine industry.

Piston pumps have an internal void, which is expanded and contracted by the movement of a physical barrier. The liquid, be it juice or wine, is physically pushed out of the innards of the pump and past a check-valve one pump-volume at a time. As one can guess from the name, in a piston pump this is accomplished by a piston that moves back and forth inside a cylinder. This causes a great deal of pulsation in the outflow from the pump. If left unchecked, this “water-hammer” can damage any hoses, piping or equipment “downstream” from the pump if not mitigated by the use of pulsation dampeners.

Rotary Piston Pumps

The rotary piston pump is a relatively new design, although these pumps have been available in the U.S. for something like 15 years. The pump cavity is cylindrical, with each of the wedge-shaped rotary pistons filling a little less than one-quarter quarter of the cavity. The two pistons revolve around a central axle but not at a constant rate. Half of the rotation is much slower than the remainder. In effect, they play chase and catch-up as they turn. This opens then closes a half-circle void. At this time, they are only manufactured by Francesca. The U.S. vendor is Collopack Solutions, and the Canadian vendor is The Wine Company. These pumps are still fairly uncommon but are suitable for most winery operations from the crushpad to the barrel room.

Final Word

Well, that’s my list of pump types one can use to move must. As I mentioned above, with the exception of the rotary piston and the helicoidal pump designs, I’ve used pretty much every pump type described here to move must at one point or the other in my career. I do have a clear favorite type of must pump (peristaltic), but most of the rest of the industry seems to prefer to use progressive cavity pumps for moving must from the destemmer, and rotary lobe pumps for pump-overs during fermentation. I view this as primarily a personal preference on my part and an artifact of the types of wines I have spent my career making. [WBM](#)

BARREL BUILDERS

Napa Valley

WOOD SELECTION

- *Quercus Petraea* – French Oak
- Hand-Selected For Uniformity
- Medium to Tight Grain
- American and Eastern European Oak Available

SEASONING

- 24 to 48 Months in Bordeaux

CUSTOMIZATION

- Lasered Logo and/or Vintage
- Galvanized or Black Hoops
- Bx, By, Chateau Ferre / Traditional
- Thin Stave (22mm) or Export (27mm)

TOASTING

- Exact Toasting Temp. Within 5°C
- Customizable Options
- 2 Stages of Quality Control

MARCHIVE
TONNELLERIE

BARRELBUILDERS.COM | INFO@BARRELBUILDERS.COM | +1.707.963.9963

SERVING NAPA VALLEY
and beyond
SINCE 1972

A Technical Review of Parsec SRL and Its Products

Richard Carey

Richard Carey is a wine consultant based in Lancaster, PA, and writes articles for *Wine Business Monthly* on winemaking practices, challenges, new equipment and laboratory analyses.

Author's Note: Readers of *Wine Business Monthly* have enjoyed articles known as Technical Spotlights to find out how wineries have produced quality wines. In this article, I will look at Parsec SRL (Parsec) as an example of a company, not a winery, that has provided substantial technological contributions and innovations to the wine industry for many years.

PARSEC BEGAN BUSINESS IN 1996 as a startup tech company known as Studio Archimede Enologia, and the acronym SAEn is the root of the name of their flagship product, SAEn5000. The company name changed in 1997 to Parsec Enologia SRL. The name Parsec—the astronomical unit of measure of 3.26 light years—was chosen to reflect how far and fast their contributions would enable the wine industry to make better wines.

A significant change in winemaking began in the mid 1990s, when many innovators began to look at the taboo of oxygen and wine. Previously, oxygen was seen as the enemy of winemaking, and many wineries went to extremes to limit oxygen contact with their wines, only to find other aromatic faults, difficulties with color management and lack luster structure in those same wines. Trade shows in France and Italy, at the time, featured two companies, OenoDev (now Vivelys) and Parsec, that exhibited equipment designed to purposefully inject oxygen into wines.

Micro-ox: The Base Technology

Micro-oxygenation (micro-ox) can be defined as a system in which oxygen is added to a liquid with abundant compounds that can interact with one another. These compounds react at sufficient rates to provide oxygen-enabled chemical changes to that liquid—in this case, wine. In addition, it modifies any combination of color, constituent molecular size and organoleptic components at such a rate that the wine can be significantly improved. However, this process can easily destroy a wine when not done according to the right parameters. Micro-oxygenation injection rates are upward of



The Parsec Oxygenius 4000 two-tank model manages up to two tanks at different rates of dosing.

0.1 mg/L per month, depending on the wine. At such rates, one can understand that precision is the important factor in injecting oxygen, because the oxygen molecule is the rate-limiting constituent.

I was particularly attracted to the Parsec company at trade shows in Italy and France because of the base technology it used to solve this problem. Its solution is to create a series of instruments that will implement a master plan of management of the entire wine production operation.

This article will review several of the components of the SAEn5000 system; a subsequent article will examine the entire system and its implications. As one might expect, the complete system is not for anyone without a considerable pocketbook; but on scale, it is a very valuable and ultimately affordable management system.

Prior to reviewing equipment, I prefer to use that equipment in my research facility so I can report on its use in real winemaking conditions. I don't rely on manufacturer claims—I verify them. While in Europe, I was fortunate to meet Luca Zanin of what is now the ATP Group and obtained an OxyGenius, a single tank dosing unit.

Parsec had developed a pressure cylinder that held a precise volume of gas at a defined temperature, and then pressurized that gas to a precise pressure

A SIDE-BY-SIDE THAT PAIRS WELL WITH GRAPES.

Every ROXOR is hand-assembled with a steel body, boxed steel frame and a 2.5L 4-cylinder Mahindra turbo diesel engine. Plus, it's durable and reliable thanks to a heavy-duty, beltless transmission. It's a work side-by-side unlike any other.



STARTING AT

\$16,599 USD
MSRP*

LEARN MORE AT ROXORWORKFORCE.COM

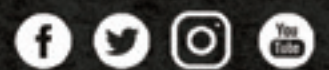

Mahindra

A Technical Review of Parsec SRL and Its Products

to solve the problem of accurately and precisely delivering oxygen at mg/L/Mo rates. Utilizing Boyles Law, the Parsec unit can calculate the number of molecules of oxygen contained by the pressurized container. When the pressure is released at a controlled rate, the number of molecules of oxygen released can be calculated. When tubing from the unit to a diffuser is connected into a known volume of wine (of which the weight is also known), the user can determine the rate of oxygen per unit of wine delivered.

Parsec micro-ox instruments deliver the correct dosage programmed by the user to conform to any external working environment. The instrument takes into consideration the gas temperature, the wine pressure on the sparger and determines if the sparger is clogged. Therefore, OxyGenius adjusts the necessary parameters to deliver the correct dose as programmed. Other systems don't take into consideration these external factors that alter the wine's programmed dosage.

In operation, the OxyGenius reduces this complexity to a simple piece of equipment. When the number of hectoliters in the tank and the rate of oxygen desired are set, it will begin delivery of the oxygen. Over the years, OxyGenius has evolved: more control over the delivery and the number of tanks to which a system can be connected have been added.

There are two lines of standalone oxygenators: OxyGenius and SAEn4000 and one line of Bus system SAEn5000 that covers 10 hL tanks to 8,000 hL tanks. The rate of oxygen delivery can be set to the desired point that is accurate to +/- 0.1mg/L/Mo. If delivery of oxygen is desired for smaller vessels, that is accommodated by proportionately lowering the oxygen rate

and adjusting the rate of delivery to equal that needed in the smaller tank. Parsec's oxygenators can be set up to deliver oxygen at a dose rate of mg/L per month, a dose rate of mg/L per day, or as a single dose. When the time is per day, the process is known as macro-oxygenation.

The OxyGenius and SAEn4000 models are expandable from one tank at a time up to 15 tanks at once. The units are equipped with a central microprocessor, using Parsec's proprietary software system of wine production management.

Currently, OxyGenius has four models that cover anywhere from 10 to 3,000 hL tanks. The rate of oxygen is then set to the desired point +/- 0.1mg/L/Mo. If delivery of oxygen to smaller vessels is needed, that is accommodated by proportionately lowering the oxygen rate and the length of delivery. The OxyGenius is flexible enough to deliver oxygen at a dose rate of mg/L per month or day. When the time is per day, the process is known as macro-oxygenation.

The OxyGenius system can accommodate anywhere from one tank at a time to more than 100 tanks. When connecting up to five tanks at a time, there is no ability for computerized control. Above that number, the main control center is permanently mounted, and a computer can be connected to the module for managing the injection of oxygen. The smaller units are priced at a point that wineries of just about any size can make profitable use of any one of these systems.

The next step up from the OxyGenius series of systems is the SAEn5000.



- Specializing in Tank Farm Project Management
- Tanks custom designed, fabricated, and installed tanks up to 700,000 gallons capacity
- Catwalks custom designed, fabricated, and installed to customer specifications
- Receiving hoppers, belt and screw conveyors built and installed
- Complete Marzola product line of screw presses, bladder presses, destemmers and dejuicers



CONTACT US: 559-233-7116 | WWW.SANITARYSTAINLESS.COM



Micro-ox Theory, Concepts and Practice

The use of micro-oxygenation is a powerful tool, but as was indicated earlier, it can destroy the wine if not used properly. I have likened micro-ox to docking the Queen Mary cruise liner—the engines need to stop a long way from the pier, or the ship will end up on 4th Street. This is because oxygen is the catalyst for many reactions that start slowly and then speed up. Therefore, winemakers should stop feeding the reaction long before it needs to cease, but exactly when that is takes experience.

In response, Parsec has developed MOX Easy, a software program that helps the winemaker determine the oxygen dose and length of time. In addition, they offer a book on theory, concepts and practice of micro-ox that helps the user understand this powerful process so that the wines can develop to their fullest potential. In summary, micro-ox can improve and soften tannic structure, increase color intensity and make it more balanced sooner.

TOP TUBE TANK RELIEF SYSTEM

Parsec was awarded a Palmare medal at the Simei 2015 show in Milan and another award at Sitevi in 2016 in Montpellier for its novel tank pressure relief system, Top Tube. Innovations developed in the European wine industry take time to reach the United States, which probably means Top Tube will arrive in this country in quantity within the next year or two.

This device provides the ability to keep stainless steel tanks full. The control unit has a nitrogen feed line connected to the tank through a tri-clamp fitting on the tank top. That unit connects to a stainless-steel expansion

chamber which automatically adjusts to keep the tank full at all times. This compensation chamber uses nitrogen to keep the tank consistently topped, even after a sample is taken or the wine volume changes due to temperature. A sensor can sound an alarm if there is no compensation liquid or if the tank has a leak. It also protects a tank if the wine expands to the point where it would overflow.

O₂ FERM X6

Fermentations need oxygen to get them going as soon as possible. The most important factor in getting yeast to start converting sugar into alcohol is providing a nutrient rich environment to create healthy cultures with robust membranes. Oxygen is one of the best fuels to kick off fermentation. Winemakers don't have to worry about adding too much oxygen to the fermentation vessel during this initial phase. If there is any excess oxygen, it is consumed by the grapes' insoluble fruit material. Grape fermentations love an oxidative environment until they cross the 2 to 3 percent alcoholic conversion. At that point, the metabolic processes shift into anerobic metabolism. After that, oxygen doesn't help.

The Parsec O₂ Ferm X6 has a 6-diffuser sequential macro-oxygenator. This unit is capable of injecting from 0.1 to 20 mg/L/day into 50 hL (1,321 gal) to 8,000 hL (211,338 gal) sized tanks. The O₂ Ferm has an automatic timer that can be set up for a minimum of 12 hours and up to 10 days. It has a built-in self-diagnostic system and can deliver up to 2,500 g/day of oxygen. This means one O₂ Ferm unit can deliver up to 3 mg/day to the maximum volume of 8,000 hL of wine, or the maximum output of 20mg/day to 1,250 hL.

Crafting Partnerships

At World Cooperage, we craft premium American and French oak barrels and partner with you to build comprehensive barrel programs you can trust, time and time again.



WWW.WORLDCOOPERAGE.COM

OXYLEVEL 2200

When adding oxygen to the wine, it is important to know exactly how much oxygen is in the wine in order to verify that the process is working. Knowing the amount of oxygen at any stage of production will help winemakers develop their own house rules on how much oxygen is the right amount for any one process step.

To provide this information, Parsec developed the Oxylevel, which has inputs from one or two probes. The probes can be either two oxygen sensors or one oxygen sensor and one pH or conductivity probe. This unit is valuable for inline processes, such as racking source and destination tanks to determine O₂ pickup, or for mixing tanks in order to achieve a complete mix. It also helps ensure the wine doesn't pick up too much oxygen during the bottling process.

EVO 1000

The EVO 1000 was created to address instances when there is either too much or too little oxygen in a wine. This unit can raise or lower oxygen levels and can also raise or lower CO₂. It operates in both closed circuit loops and inline processes. The EVO 1000 can be used for deoxygenating must so that the juice does not reach any critical level. In this mode, the EVO 1000 can reduce oxygen levels to less than 0.15 ppm



The Parsec Evo 1000 is an oxygen/CO₂ dosing unit that can add oxygen to fermenting tanks. It can also add CO₂ to wines that need just a little sparkle to freshen, or a full 8g/L CO₂ for Charmat champagne.

oxygen in must. If the oxygen is removed from a wine, then during the wine's time in tank, it will use much less SO₂. The ability to run a wine in a closed circuit reduces the possibility of removing oxygen in one direction, then placing it back into the tank and regaining the oxygen back into the wine.

Inline carbonation is another valuable process for the EVO 1000. It can deliver as little as 0.1 to 1.5 g/L for increasing a wine's acidity at bottling by giving the wine a little pétillance. The EVO 1000 can also add sufficient CO₂ to get full sparkling wine volumes up to 8 g/L. Thus, the EVO 1000 has a flow rate of direct injection of CO₂ from 16 L/m (4 gal/m) to 216 L/m (57 gal/m). It can also inject from 0.1g/L to 9 g/L CO₂.

MAXIMIZATION OF MACERATION WITH SELECTIVE EXTRACTION

Parsec services wineries of all sizes with the intention of improved wine production. One device that is useful for wineries of all sizes is the Smart Spreader, a cap moistening device that floods the cap of tanks ranging from 40 hL (1,057 gal) to 600 hL (15,850 gal).

The Smart Spreader is designed to handle pump-overs for any shape of tank or hatch position. It can be placed on round or square tanks and does not require any significant modifications to the tank in order to be effective. The spreader uses two motors to operate the



STAINLESS STEEL TANKS

Generations of experience, know-how and innovation are evident in the quality construction of our stainless steel tanks. We offer many types of closed and open top tanks as well as a wide variety of options for your customization.

All made with quality down to the last detail!

FOR THE LOVE OF WINE

Euro-Machines
Vineyard and Winery Equipment

California 707-864-5800
Oregon 503-776-9118
Virginia 540-825-5700
www.euromachinesusa.com

outlet, which is parabolically shaped so that the juice movements can be directed by the two motors to cover the entire surface in a proscribed pattern. This spreader can also be directed to clean the tank.

To increase its impact on wine quality, Parsec acquired the technology of the Nectar Tank company in 2012, including the Nectar winemaker tank equipment that works to selectively extract soluble wine components from grapes using isobaric immersion. This equipment can be used on tanks ranging from 40 hL (1,057 gal) to 600 hL (15,850 gal). The tank is built to withstand a slight pressurization of 0.4 bars. Their patented system uses three pneumatic valves to control the wine processing.



Nectar Tank

The first step in the Nectar isobaric immersion tank process is pomace pressurization, caused by closing two valves which then moves the pomace into the top basin that holds 10 percent of the tank's volume. On sequential release of the valves, isobaric immersion transfers the pomace from the basin to flood the cap to the lower section. This is the action that solubilizes the extractable components. The third and final effect is called the "Nectar effect." The purge valve is quickly opened, which releases oversaturated dissolved CO₂. The must rises and loosens the pomace, creating a fluid cap filled with fermenting wine.



The Parsec Intelligent Cap Spreader with controller covers any tank circular or square up to 600hL.

The Air Mixing MI process extends the pump-over process for larger size tanks. It creates a pump-over using modulated gas injection for large tanks ranging from 1,000 hL (26,417 gal) to 5,000 hL (132,086 gal). A full description of this process will be included in a second article that will focus specifically on the Parsec Integrated System SAEn5000. This unit incorporates many equipment elements discussed in this article but adds much more unified control over the entire production of wine.

Parsec's Aphromate Plus, an adaptive dynamic process control system for Charmat method of sparkling wine production will also be reviewed in that article. [WBM](#)

To readers: Please send any suggestions of companies serving either wineries or vineyards that you believe have made significant contributions to the wine industry for review in future articles to: rcarey@tamanend.com.



St. Patrick's of Texas

2,000,000 Liters of Tanks In Stock



Letina tanks,
sanitary valves
& fittings.





StPats.com

Compressor System Audits

Monitoring the Heart of Your Winery

Bill Pregler



Bill Pregler has worked in the winery equipment industry for many years and is a writer for *Wine Business Monthly*.



COMPRESSORS ARE WONDERFULLY SIMPLE machines, yet so many pieces of equipment are contingent upon their health; if they stop functioning, you have a serious issue.

Whether for bladder presses, optical sorters, air pumps, pneumatic punch-down devices or even nitrogen generators, wineries are increasingly operating machinery that use compressed air, and the use of that air must be done in a timely, and often critical, manner.

While many people consider a compressor merely a machine, you should think about compressors as the “fourth” utility, after gas, water and electricity. Just as with your utility usage, compressors demand constant audits, from appropriate sizing to regular maintenance schedules. Today, they are also closely monitored by the accountants who pay a business’ energy bill.

The theme of this article, therefore, is the audit. For the proactive winery, audits begin by researching efficiency standards and performance based on need. The place to start is with the people who help design comprehensive and efficient systems.

Getting Started: The Vendor Audit

Not every winery will need a complete compressed air system—though for long-term growth projections, and to achieve an average five- to 10-year ROI, it behooves you to honestly assess your potential growth as well, whether you’re a startup business or an existing facility in need of an update. No matter the need, there are several types of compressors available.

For very small wineries, a visit to a local hardware store for a store-bought reciprocating piston compressor might be satisfactory; but as winery demands become more sophisticated, an experienced vendor will likely be needed to vet original equipment manufacturers (OEMs).

Your local compressor dealer should know the various OEMs available and the related system components. I would suggest you visit companies that understand industrial air systems and avoid the big box stores because customer service is so important for a winery’s business. This is your insurance policy beyond the warranty, since every dealer wants to earn your loyalty and long-term business, and they will help you solve any unforeseen problems that arise.

There are two types of vendor specialists. I met with Michael Houston, president of Air Technology West in Santa Rosa, Calif., a long-time air compressor supplier that represents several different companies. In the same territory is Will Whitehorn, a local and exclusive field representative for Germany-based Kaeser Compressors, Inc. Both companies start the purchasing process with a site audit and an owner or winemaker interview.

Kaeser has an in-house program called the Air Demand Analysis (ADA). Sizing an upgrade system begins with an assessment of existing components, including all plumbing. Major efficiency losses are often due to problems with simple solutions, like old plumbing leaks. Vendors, like Kaeser, will use ultrasonic guns to detect these issues using sound.

Air compressor system designs are always made with your business goals in mind, but know that maintaining and upgrading systems are common components of these companies’ businesses.

At Kaeser, a field representative will data-log existing equipment while it’s in operation and install flowmeters to monitor kilowatt usage to cubic feet per meter (CFM) output. Houston said Air Technology does the same, all the while determining what the owner has versus what he or she needs for efficiency upgrades or future expansion. Often positive results can be found with simple solutions, such as new copper plumbing, and not necessarily extensive mechanical investment. This initial assessment is also a good time to schedule periodic audits as part of regularly scheduled maintenance.

Equipment Audits

Vendors will establish duty cycles of your system based on the actual draw of individual components. This shows how long compressors must run, and how often, to satisfy the demands your business operations place on it. A vendor's job is to determine the right compressor output. It is estimated that most industrial installs only operate at 50 to 70 percent of load capacity, which means you might (again) be able to run with a smaller compressor.

Considerable savings are achieved by only supplying what you need and when; i.e., the difference between the amount of time a compressor is used in the two months of crushpad use versus two months of pump-overs. However, most air systems are sized to deliver maximum capacity to meet the highest demand. Discuss this with your vendor.

Oversight and OEM audits are provided by the Compressed Air and Gas Institute (CAGI), a third-party, voluntary membership for compressor manufacturers. Manufacturers submit new and existing compressors for performance verification so vendors have current and accurate data when designing a system.

Maybe you heard?

Bin to Bottle
added 250K gallons
of Capacity.

That means we
have room for you.

- Although BTB is big and getting bigger...we FOCUS on the small stuff.
- Did you know we have many clients under 25 tons?
- All we do is make wine for others. This is IMPORTANT!
- There are more options for custom crush than ever before but...

There is really only one Choice.

Call now and find the custom crush home you've been looking for.
Matthew@bintobottle.com or 707-492-5270



KAESER COMPRESSORS		COMPRESSOR DATA SHEET	
Rotary Compressor: Variable Frequency Drive			
MODEL DATA - FOR COMPRESSED AIR			
1	Manufacturer:	Kaeser Compressors, Inc.	
2	Model Number:	SFC 22 - 125psid/460V/3ph/60Hz	Date: 03/24/15
	<input checked="" type="checkbox"/> Air-cooled <input type="checkbox"/> Water-cooled <input checked="" type="checkbox"/> Oil-injected <input type="checkbox"/> Oil-free	Type:	Screw
		# of Stages:	1
3	Rated Operating Pressure	125	psig ^b
4	Drive Motor Nominal Rating	30	hp
5	Drive Motor Nominal Efficiency	91.7	percent
6	Fan Motor Nominal Rating (if applicable)	.67	hp
7	Fan Motor Nominal Efficiency	76.5	percent
8*	Input Power (kW)	Capacity (acfm) ^{a,d}	Specific Power (kW/100 acfm) ^d
	28.80	Max. 152.2	18.92
	26.19	139.5	18.77
	18.43	96.4	19.12
	13.40	65.3	20.52
9*	8.90	Min. 35.7	24.93
9*	Total Package Input Power at Zero Flow ^{a,d}	0.0	kW
10	<p>Note: Graph is only a visual representation of the data in Section 8 Note: Y-Axis Scale: 0 to 35; X-Axis Scale: 0 to 175 X-Axis Scale: 0 to 25% over maximum capacity</p>		

*For models that are tested in the CAGI Performance Verification Program, these items are verified by the third party administrator. Consult CAGI website for a list of participants in the third party verification program: www.cagi.org

NOTES:

- Measured at the discharge terminal point of the compressor package in accordance with ISO 1217, Annex E. SCFM is actual cubic feet per minute at inlet conditions.
- The operating pressure at which the Capacity and Electrical Consumption were measured for this data sheet.
- No Load Power: In accordance with ISO 1217, Annex E, if measurement of no load power equals less than 1%, manufacturer may state "not significant" or "0" on the test report.
- Tolerance is specified in ISO 1217, Annex E, as shown in table below:

NOTE: The terms "power" and "energy" are synonymous for purposes of this document.

Member	Volume Flow Rate at specified conditions		Volume Flow Rate		Specific Energy Consumption	No Load / Zero Flow Power
	m ³ /min	SCFM	%	%	%	%
ROT 601	Below 0.5	Below 15	±1.7	±1.9	±1.9	±1.0%
	0.5 to 1.5	15 to 50	±1.6	±1.7	±1.7	
	1.5 to 15	50 to 500	±1.5	±1.6	±1.6	
10/11 ROT	Above 15	Above 500	±1.4	±1.5	±1.5	

This form was developed by the Compressed Air and Gas Institute for the use of its members. CAGI has not independently verified the reported data.

The CAGI Performance Verification Program is used to qualify OEM specifications.

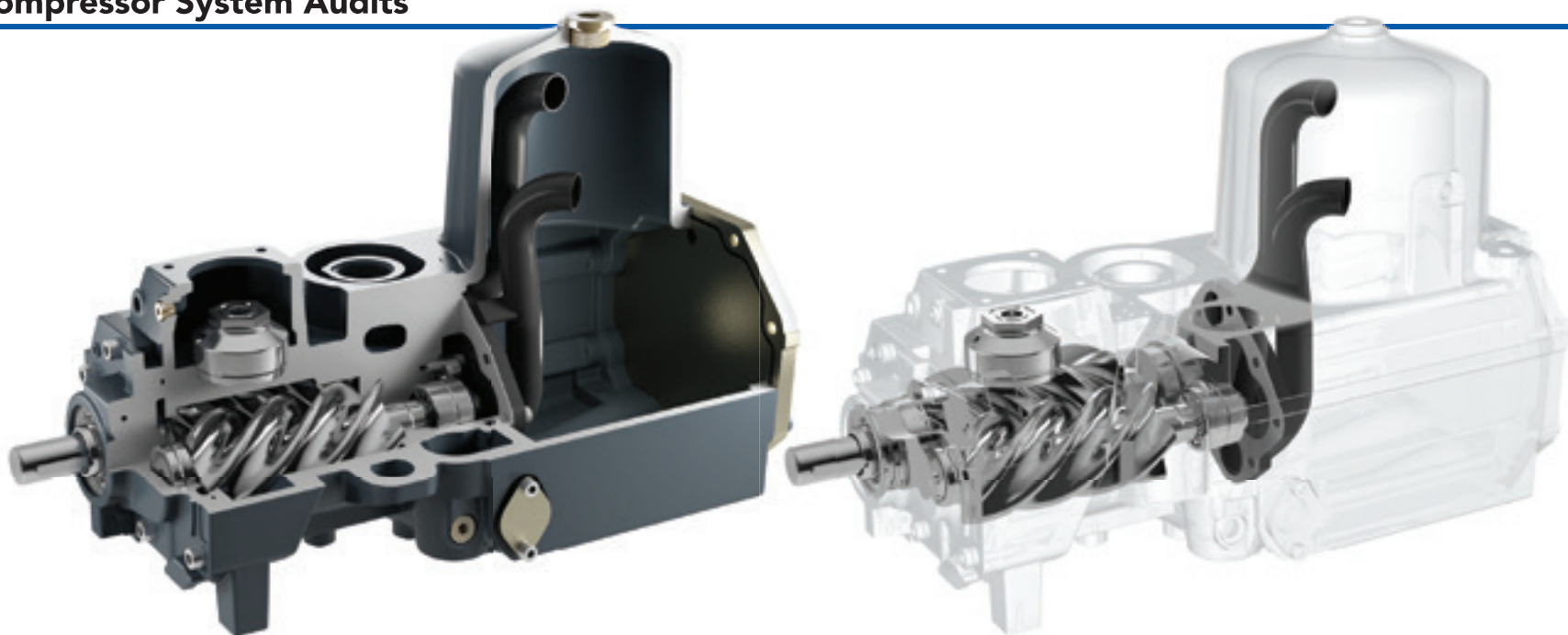

CHAMPION PRODUCTS

Popular rotary screw technology is highly efficient, quiet and virtually maintenance free.

The most important information is the graph of specific power. Power translates into energy (and money), and your vendor will want to know the kilowatts (kW) per 100 actual cubic feet per minute (ACFM). Not only does this help right-size your system, but it also foreshadows your electric bill at the end of the month.

Curiously, when reading performance data on any given compressor, after horsepower, kW ratings and ACFM output, the next most critical factor is A-weighted decibels (dBA) or noise levels.

This is huge, and not to be dismissed, for the benefit of your cellar workers and the overall winery environment. Hands down, this is the largest

complaint about reciprocating (piston) compressors: today's compressors, particularly rotary screw and rotary vane compressors, are often housed in sound-insulated, thermo-controlled enclosures with cooling fans. The goal is to reach 62 to 70 dBA, which is quieter than a dishwasher.

All companies interviewed emphasized the importance of maintaining as small an installation footprint as possible. Not only are most compressors becoming more compact, but with a simple system design, you can minimize plumbing and increase flexibility in the compressor's location. Having the ability to move equipment throughout the year is a distinct advantage during seasonal demands.

SERVING YOUR NEEDS

Since 1946, we have been manufacturing bottling and labeling machines with passion and constant innovation. Our machines—running from 15 up to 350 bpm—can be found in the world's best wineries, and an international network ensures an impeccable post-sales experience. One of our fastest-growing markets is the United States, where for over 40 years we have partnered with Prospero. Now we are consolidating our presence here with seven service centers across North America as well as the Gai America branch in California (*), founded in 2016, to guarantee the highest level of support for our clients.

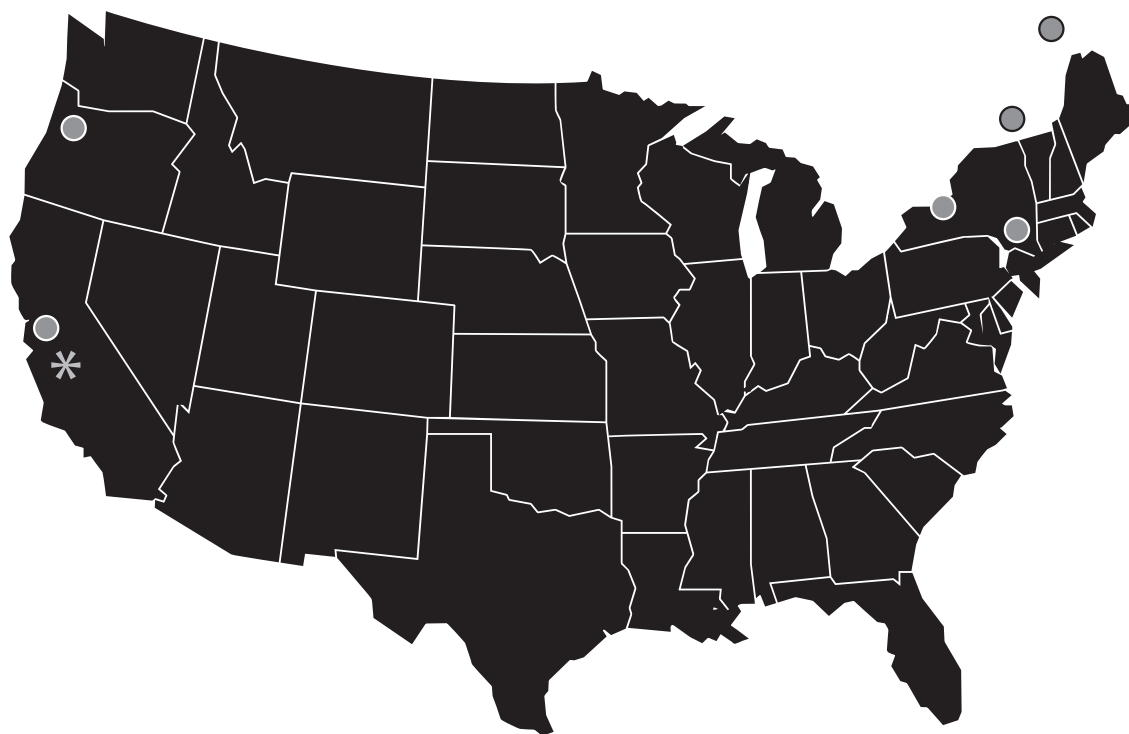

GAI AMERICA INC.
149 GROBRIC CT, SUITE D - FAIRFIELD CA 94534
TEL. +1 707 862 2323 - CONTACT@GAI-AMERICA.COM
WWW.GAI-AMERICA.COM

PROSPERO

GAI
A M E R I C A



CONCRETE WINE TANKS
SONOMA CAST STONE

Time to Re-Think The Oak Barrel



Now You **Can Age** Wine In Concrete

Concrete fermentation benefits continue in aging fine wines.

- A Fraction of The Cost of Oak Barrels
- Last Decades Longer Than Oak
- Require 1/3 less space, 1/2 The Labor
- Fill, Drain, and Clean the Tanks in Place
- Much Easier to Clean, Using Less Water
- Virtually No Evaporation and No Topping

NOW AVAILABLE

WINE ANALYTICS REPORT

The wine industry's leading data source for market strategy and analytics



A monthly interactive digital publication.

The latest wine industry metrics, market analysis and trends shaping the wine industry.

Ensure your company's success by making informed business decisions based on market conditions and emerging new trends.



Be the first to receive the
Wine Analytics Report!

wineanalyticsreport.com • 707.940.4744

Compressor System Audits

Energy Audits

Pricing the cost of a new compressor will include everything from fixed material, equipment and installation cost to maintenance programs. These are determined by an early audit with your vendor. "What keeps the winery staff happiest are sustainable energy savings. Today, everyone in the tasting room or the cellar seems to take this seriously," Houston said.

Winery owners have a wealth of information available to them about energy savings and efficient installations. Start online with *BEST Winery Guidebook: Benchmarking and Energy and Water Savings Tool for the Wine Industry* from Lawrence Berkeley National Laboratory or Washington State University's Energy Program. Their recommendations begin with properly sized equipment. There are even training programs available for you and your staff, and I would recommend keeping everyone engaged in the exercise.

For more in-depth energy standards, read the California Building Code, specific to compressors. These regulations tend to lean toward new installation but are relevant for upgrades just about everywhere, in any state. Lastly, contact your local utility provider as rebate incentives and financing are often available with sustainable energy compliance.

Air Quality Audits

A winery is subject to the regulations of the food and beverage business, especially regarding sanitation, and so, rightfully, one expects air quality to be a consideration. Your vendor is aware of this and will recommend any number of filters up and downstream of the compressor. Typically, this will be determined by your choice of compressor.

Ingersoll Rand will supply you with "Class O," ISO 8573-1, 100 percent oil-free air. This is great for the dentist's office or operating room, but I cannot think of any winery that needs this added expense. A rotary screw or vane compressor will easily get as low as .008 parts per million (ppm); and as this air is not necessarily in contact with wine, that should be sufficient. Naturally, filters should be a part of regular maintenance schedules. Plugged filters can also dramatically reduce efficiency.

There are also air dryers available. After warm, compressed air is discharged, water vapor condenses, which then migrates downstream throughout the entire system. In particular, you do not want water to contaminate the inside of your equipment. Typically refrigerated, the dryers remove moisture, are easy to install and maintain. Again, your vendor will specify capacity based on the system output.

Training and Maintenance Audits

When I sold winery equipment, I always took customers to our parts and service departments to show off our technical training certification. You should expect the same. All vendors must be able to install and service their installations, but on-site, downtime maintenance is critical.

Most companies I interviewed have well-stocked service vans roaming their territories, providing genuine OEM-certified replacement parts to address immediate problems. I would also suggest you inquire about available emergency rentals or loaners heading into crush. A pre-crush audit is a great idea.

Oscar Lang, sales manager for Champion Air Tech, discussed how its 480 authorized U.S. service centers stay current with online training modules in which all technicians must regularly participate. Kaeser also provides after-sales service with a national network, including on-going training and even cross-training for non-Kaeser equipment. Chicago Pneumatic emphasizes its online service center "locators" and encourages customers to use this tool to find local support in your area. Other major players in the space offer the same.

Pump Styles

There are only a few compressors that apply to wineries and, of those, only two really satisfy all the demands we have discussed. We want clean and dry air, a quiet operation, extended duty cycles, high energy efficiency and a small space.

Reciprocating, or piston, compressors are generally for industrial use. By nature, they come with piston maintenance issues, like rings, valves, crankshafts and oil. Noisy and typically “dirty,” they require strict filtration, generate excess heat and lower duty cycles and are generally for more intermittent use. You expect to see these in automotive environments.

Scroll compressors have been around for a very long time, and today are generally used more for refrigeration and air conditioning. They are smaller, with few moving parts and are oil-free, but expensive to buy and maintain. With lower horsepower, they are widely used in the pharmaceutical industry.

Rotary vane compressors are somewhat limited in psi output, but for the small winery, I highly recommend these. You see them throughout the nation’s growing mobile bottling and canning fleets as they have a compact design, are one of the quietest (62 dBA), are easily portable, maintain a low speed throughout its long life and provide clean and dry air. They are often included as the OEM onboard, internal compressors for bladder presses from Europe. All-in-one designs, they include filtration and are easy to maintain and install.

Rotary screw compressors constitute the majority of all winery installations. Based on CAGI performance ratings, they will afford a winery long, continuous service, are very quiet, offer low maintenance, provide quality air, generate little heat, and when run with a variable speed drive (VSD), provide extended duty cycles and air exactly when needed.



CHICAGO PNEUMATIC

A sound panel removed shows easy access to a modern, compact design.

A screw compressor includes two internal, interlocking (helical) rotors. Air enters the space between the rotors; the space between the rotors gradually decreases, reducing the volume and thereby increasing the pressure. Utilizing a VSD automatically controls air output by optimizing speed ranges based on load.

What’s Cool

While attending airplane engine school, you are taught a jet engine is simply a compressor: the underlying concept is to “inhale-squeeze-blow.” That will send a military jet straight up for miles at an incredible rate. The same description could be used to describe a backpacker inhaling and forcefully exhaling to get a fire going. Using that logic, there is no mystery about compressors.

Compressors are so utilized throughout most industries worldwide—the wine industry is no different. The key is getting the correct equipment to satisfy your specific needs—and that begins with an on-visit facility audit by your local, certified vendor. [WBM](#)

Jean-Louis Bossuet and his son Yoan



staff@boswellcompany.com (415) 457-3955 www.boswellcompany.com

Winemaker Trial

Cap Management Options for Red Wine Development

Production winemaker Andrew Brooks looks at two different extraction methods and how those methods affect the fermentation process and the resulting wine

Stacy Briscoe



Author's note: During the time of this interview, the experiment was in the early stages. Thus, the questions and answers published here are a reflection of an in-progress trial.

PHOTOS: BRYAN AVILA

ANDREW BROOKS (second from left) has been making wine in and around Napa since 2005. He's been at Ashes & Diamonds since 2017, deeply interested in making wines of restraint and integrity.

TRIAL OBJECTIVE: To understand how the process of destemming red winegrapes, as well as destemming and then crushing red winegrapes prior to fermentation, affects the resulting wine style and quality.

TRIAL DESCRIPTION: Merlot and Cabernet Franc grapes were harvested from the same vineyard blocks in Napa's Oak Knoll District. Two lots were created from each block: one in which fruit was destemmed but not crushed, and one in which fruit was destemmed and then crushed prior to fermentation. All other fermentation variables remain constant; lots are kept separate.

Lot 1: Merlot destemmed prior to fermentation

Lot 2: Merlot destemmed and crushed prior to fermentation

Lot 3: Cabernet Franc destemmed prior to fermentation

Lot 4: Cabernet Franc destemmed and crushed prior to fermentation

CONCLUSION: In progress.

Winemaker Progress Report

Why are you interested in studying different cap management techniques for red wine?

Brooks: We're interested in cap management because it's a critical tool in crafting red wines. Red wine color and texture are shaped strongly by what we do or don't extract from the fruit during the fermentation process, so this is a critical technique for us to understand. This year, we're primarily interested in understanding the difference between fruit which has merely been destemmed, and fruit which has been destemmed and then crushed prior to fermentation. To some extent we're also looking at pump-over length and frequency and fermentation temperature.

Which varieties are you running the trial on?

Brooks: So far, we've been looking at Merlot and Cabernet Franc, mostly from the Oak Knoll District of Napa Valley. We may also experiment a bit on some other fruit. The reason is mostly programmatic/logistical: We need vineyard blocks large enough and uniform enough to be split in half so we can start from a somewhat even footing. It's always a bit of an approximation with red fruit since each vine is a little different and there's no way to make the starting material truly exactly identical, but we do our best.



Critical thinking skeptic that you are, some gimmicky ad with shiny pictures and bold slogans probably won't even get your attention. Maybe a few cold hard facts and a little math will. Let's say your winery is crushing 1,000 tons of grapes, in turn aged in 1,400 French oak barrels to achieve 50% new oak. You sell 70,000 cases of wine each year, with an operating profit of \$3,000,000. Consider this: In the field of barrel alternatives StaVin is unrivalled, with 30 years of proven experience. Tirelessly hunting down vastly superior source product and continually innovating more efficient infusion techniques. Using StaVin *will* improve your wine *and* save you upwards of 94% in oak costs. Which means 33% more profit or \$1,000,000 go into your pockets, instead of directly into the trash. Got your attention now?



CANNED WINE?



CRAFT
CANNING + BOTTLING

HIGH CAPACITY. LARGE VOLUMES. DEDICATED TEAM.

CRAFTCANNING.COM
971-231-5497

CRAFT IS HERE TO HELP YOU MOVE YOUR SPARKLING OR STILL WINE INTO ALUMINUM CANS IN 375ml, 250ml, AND 187ml SIZES.

- LATEST MOBILE CANNING EQUIPMENT
- VELCORIN AND NITROGEN DOSING
- OUTFEED LABELING SYSTEM – THE MOST FLEXIBLE FORM OF BRANDING!
- WE COME TO YOU WITH OUR EQUIPMENT, OR COME TO US FOR CO-PACKING SOLUTIONS.

Winemaker Trial

Cap Management Options for Red Wine Development



Briefly describe how you are setting up the trial.

Brooks: As mentioned above, we are comparing our standard practice (destemmed, un-crushed fruit) with fruit from the same vineyard and block, which has been crushed after destemming. We're doing our best to hold all the other fermentation variables constant so we can see the difference that crushing the fruit makes in terms of aroma, flavor, texture and yield.

Who else on the winemaking team is involved in this experiment? Do you or your colleagues have any initial predictions or desired outcomes you'd like to see at the conclusion of the trial?

Brooks: We're a small organization, so everyone on the winemaking team is involved to some extent. Steve Matthiasson is actively involved; Diana Snowden-Seysse hasn't crushed any of the fruit for her wines, but she's watching us intently to see if this technique is one she might employ in the future. Kasy Khaleli, our owner, generally gives us a wide berth to experiment, but he's always keen to know what we're up to, and to that end, he's also interested in the outcomes of this trial. I think we're expecting a bit more tannin and extraction, a bit more color and power and maybe slightly increased yields from the crushed fruit, but we'll wait to see.

How do you plan to gather and compare data?

Brooks: We're working with Peter Salamone and Bryan Avila at Research Oenovation Collective (ROC) to help structure this experiment, along with many other wineries doing similar trials. ETS is doing the phenolic analysis, and the ROC folks are gathering and crunching all the data. So, we keep a daily eye on the ferments as we would for any other fermentation, and we send some additional samples to ETS for analysis. This ensures that our data are able to be directly compared with the results from other wineries and that measurements are taking place on the same equipment and according to the same protocols, so that the results can really be compared with some measure of confidence.

Thus far, have you encountered any complications? If so, how will you address these issues?

Brooks: Nothing specifically. We don't have a large number of small, equal-sized tanks, so just having vessels in which to ferment these lots can be a little tricky. In this case, we chose fruit that would easily fit equally in two identical tanks. If we really wanted to do a lot of permutations, we'd need to outfit our cellar to more easily accommodate that.

NAPA FERMENTATION SUPPLIES

YOUR ONE-STOP SHOP SINCE 1983!

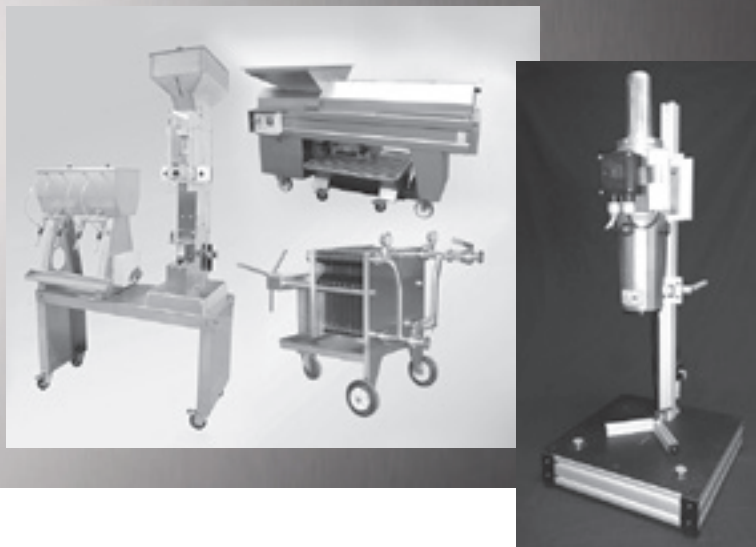

CONTACT US TODAY!

575 Third St. Bldg. A Napa CA 94559
707-255-6372 | napafermentation@aol.com
www.napafermentation.com

The non-profit **Research Oenovation Collective** leads the advancement of practical winemaking by providing a collaborative platform for applied research and innovation.



**RESEARCH
OENOVATION
COLLECTIVE**

Become part of the force that moves winemaking forward

Membership Has Its Privilege

- Attendance at all **ROC Regional Meetings**
- Full Access to all **ROC Reports** of Research Trial Results
- Focused Discussions on Topics of Interest with your **Grower and Vintner Peers**
- Input on Annual **Research Trial Topics** with Optional Participation
- Create **Oenovation Synergy** by Collaborating within a Critical Mass organization
- Access to **ROC Exclusive Invitation Only Events** including:

ROC Appreciation Assembly

ROC Educators Forum



Members Can See the Data, Taste the Data

ROC Reports and trial wines for the **Non-Saccharomyces Yeast Trials** and the **Hyper-Oxidation of White Juice Trials** will be presented and discussed at the ROC Members Regional Meetings April 6 – 10:

DATE	REGION	LOCATION
April 6	CA - Central Coast	Paso Robles - San Luis Obispo
April 7	CA - Santa Cruz Mountains	Los Gatos - Saratoga
April 8	CA - North Coast	Napa Valley College - North
April 9	OR - Willamette Valley	Newberg - Dundee
April 10	WA - Columbia Basin	Tri-Cities - Richland

Become a part of the growing ROC family by joining at the **Membership link** on our website www.ROCwine.org/membership-roc/ or simply call **(707) 799-9463 (WINE)**
All this for **annual membership dues of only \$350** ...don't delay – **Join Today!**



The **ROC** coordinates industry resources on a platform for applied research to drive wine aesthetic, production efficiency and resource sustainability through a winemaker driven agenda. ROC fills a gap in **wine industry research** by providing an unbiased **applied research** function bridging discovery and application while integrating **oenovation** in both tools and processes.

www.ROCwine.org

How far along are you in this trial? Have you been able to see any results yet?

Brooks: The first lots didn't show as much difference as we were expecting, but perhaps we were a bit too conservative with the crushing activity. One gets nervous about making the changes too extreme, and this piece of equipment was new for all of us. We'll give it another go with slightly more aggressive crusher settings and see if we see a larger difference.

Based on the outcome of the trial, do you plan to adjust any winemaking practices? Do you think certain varieties would benefit by changing the cap management routine?

Brooks: It's talked about *ad nauseam* in wine, but finding balance in structure, aroma, flavor and texture is really everything when it comes to winemaking. That "just right" spot for any given wine, from any given vineyard, in any given year is what we look for. In our specific case, because we're interested in what I tend to call "wines of restraint" (wines of moderate size and body), any specific element that's even a little bit off the mark sways the wine further than it would in a larger, more opulent wine. So, getting everything just right is all the more important. Having a deeper understanding of how to help guide a wine there and what tools can be used to help that wine best express a sense of place and time is always useful. So, yes, we may

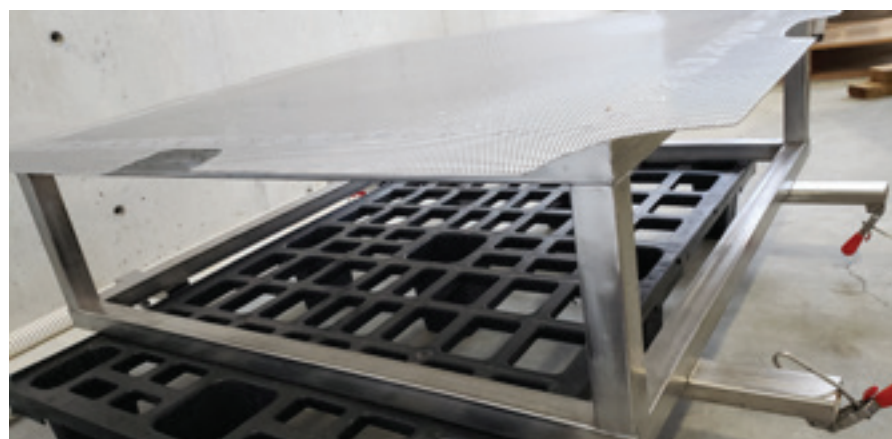

change some practices based on the outcome of this experiment. Or we may learn that this particular technique isn't a great match for the fruit we work with and the style of wine we make, and we'll try something else next year.

After this trial is complete, will you and your colleagues repeat the experiment?

Brooks: Yes, certainly! One of the central challenges of winemaking is the limited number of iterations; we only get to do this once a year, and each year produces a unique and particular set of challenges. One data point is good, but it's far from conclusive. **WBM**

1000 French winemakers trust VINEA oak.

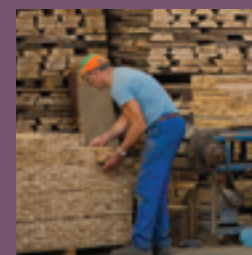
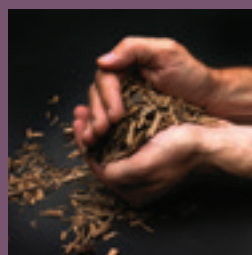
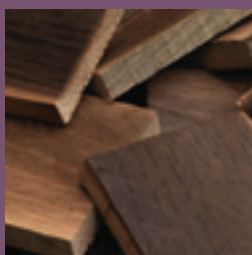
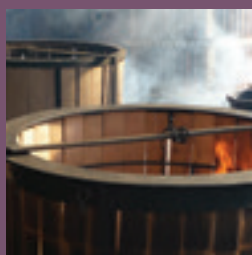
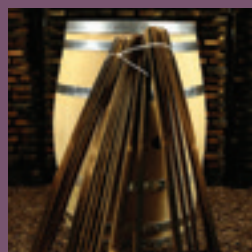
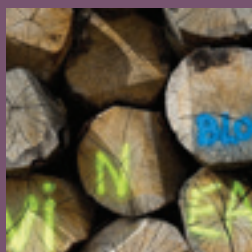

INSERTS

TANK FANS

SEGMENTS

CHIPS

SQ LINE



V I N É A
Forêts et Arômes du Monde

*The Inventor
of Ceramic
Toasting*

The Boswell Company

145 Jordan Street • San Rafael CA 94901

(415) 457-3955 • staff@boswellcompany • www.boswellcompany.com



BOHEMIAN CRYSTAL TOP

VINOSEAL

Born of sand and flame, glass has always been a natural material. Did you know that glass, traditional material used for manufacturing bottles and uniquely used for the Vinoseal closure, is completely recyclable without any loss in quality? Even the sealing ring is recyclable in the same way as low density polyethylene. The result is 100% recyclable closure. We are committed to a sustainable future of packaging. For more information visit vinoseal.us

For the love of nature

100%
*recyclable
closure*





The Climate is Changing, Whether We Like it or Not

What it means to winegrapes and what you can do about it

Mark Greenspan

SCOTT SUMMERS

I'M NOT AN EXPERT in climatology, and I'll bet most of you are not either. That is why I listen to experts on the subject of climate change. I concluded, long ago, that not only is it real, but humankind has played a large part in the most recent and dramatic changes in weather patterns and weather-related events. I'd like to avoid politics in this viticulture column, but I find it painful to hear that deniers are still out there. Sure, there are some scientists that deny anthropogenic causes for climate change, but they represent only a tiny minority of scientists who have seen enough evidence supporting man-made climate change. In fact, many of the scientists being touted by climate change deniers are not climate scientists at all—some are not true scientists at all.

What struck me and made me a believer many years ago, was the dramatic spike in atmospheric CO₂ concentration over the last several decades relative to levels in the distant past. According to a National Aeronautics and Space Administration (NASA) graphic,¹ over *hundreds of thousands of years* CO₂ levels fluctuated between 200 and 280 ppm, based on data collected from ancient ice cores. In 1950, CO₂ spiked to more than 300 ppm and continued to rise to its current level of over 400 ppm. So don't tell me that humankind isn't, at least in part, the cause of an extreme and rapid rise in CO₂ unlike any other in the last 800,000 years or so.

Dr. Mark Greenspan has more than a quarter-century of scientific viticulture research and viticultural field experience. He specializes in irrigation and nutrition management, yield and canopy management, vineyard climate and microclimate, vineyard design and vineyard technology. He is the founder of Advanced Viticulture, Inc. based in Windsor, California (www.advancedvit.com), providing consulting, technology, vineyard management and vineyard development for wineries, winemakers and wine growers devoted to producing premium wines. Please direct queries to mark@advancedvit.com or 707-838-3805.



CO₂ isn't the only greenhouse gas (GHG). According to Environmental Protection Agency (EPA) graphics,² methane levels fluctuated about a mean of 500 ppm over that same time span and have spiked in recent decades to about 1,800 ppm. Nitrous oxide, a persistent and strong greenhouse gas, fluctuated above and below a mean of about 250 ppm over that long stretch of time and has risen to about 330 ppm in the present time.

Yes, humans have created these changes, and one does not need to be a climatologist to understand that the burning of fossil fuels by an ever-increasing population has caused this change. It both surprises me and sickens me that there are still people who buy into the propaganda that these are normal phenomena we are witnessing. But I said I wouldn't get political...

References

¹ climate.nasa.gov/climate_resources/24/graphic-the-relentless-rise-of-carbon-dioxide/

² www.epa.gov/climate-indicators/climate-change-indicators-atmospheric-concentrations-greenhouse-gases



1%

For the second year in a row American AgCredit issued a full 1% cash patronage distribution, resulting in a record \$115.4 million cash back to our members for 2019.

It pays to be a member.



AMERICAN AGCREDIT
MONEY FOR AGRICULTURE

Find out how it works at AgLoan.com/patronage
or call us at 800.800.4865.

A part of the Farm Credit System. Equal Opportunity Lender.

THE MOST INTELLIGENT MACHINE FOR YOUR VINEYARD.



MORE POWER, COMFORT, AND VERSATILITY WITH THE UNDISPUTABLE HARVEST QUALITY BRAUD PROVIDES.



Powered by FPT Industrial common rail electronic engines, BRAUD harvesters give you improved output and economy. With a choice of four or six cylinders, the engines deliver more power and torque with 35% fuel savings on average.

The BRAUD SDC system is recognized as the best picking system in the industry. Each shaking rot is independently hinged for perfect control of the shaking action, with maximum flexibility for gentle picking.

The proven NORIA system, with its poly-urethane baskets, ensures the most gentle treatment of the vines and harvested crop, without ground losses.

The BRAUD harvester cab is fully suspended and sound-proofed for a smoother, more comfortable ride. The pressurized cabs with heat and air-conditioning offer optimum comfort and protection during harvest, spraying and other operations.



Turlock, CA (209) 632-3931 Santa Rosa, CA (707) 586-1790 Fairfield, CA (707) 425-9545 Stockton, CA (209) 948-5401 Ukiah, CA (707) 468-8880

Quality People Quality Products® | GartonTractor.com | 1-877-TRACTOR

© 2017 CNH Industrial America LLC. All rights reserved. New Holland is a trademark registered in the United States and many other countries, owned by or licensed to CNH Industrial N.V., its subsidiaries or affiliates.

What is Changing and What Does it Mean When Growing Winegrapes?

I attended the Sustainable Ag Expo in November 2019 and listened to two speakers on the topic of climate change. Tapan Pathak, an extension specialist researcher at UC Merced, is a specialist in climate adaptation in agriculture. He stated that while temperatures are rising, the maximum daily temperatures are rising only modestly while the nighttime minimum temperatures are rising at a higher rate over time. A paper in which Pathak was lead author³ showed that an 11-year running average of California temperatures has risen above the long-term average by about 1° F since 1980, but the recent decade saw deviations from the mean up to and over 2° F. If you think that only 2 degrees doesn't mean much, think again. Over the growing season, that level of increase kicks a region up a whole notch in the Winkler classification.

Warmer night temperatures will have an effect on fruit maturation that is distinct from daytime temperatures, so the phenomenon of rising temperature minima should not be taken casually. Photosynthesis occurs only during daylight hours for the grapevine, but vine and berry metabolism continues to take place during the night. Berry metabolism uses malic acid as its primary source of energy, so warmer night temperatures should stimulate a more rapid degradation of malic acid, leading to fruit with lower acid concentration at harvest. On the other hand, secondary metabolite production could potentially increase as well, which could have the effect of a faster phenolic maturation rate under warmer night conditions. Hence, higher night temperatures could be detrimental to warmer regions while having a potential benefit to growers in the coolest of regions. That benefit could be swamped out in the bigger picture, however, as growing seasons could be shortened both by temperature increases and more dramatically changing weather conditions during the growing season.

Gregory Jones, professor and director of the Evenstad Center for Wine Education at Linfield College in the Willamette Valley, Ore., spoke at the Expo and stated that a 1° F increase in average temperature would shorten the season from budbreak to harvest by between five and 15 days. That means that fruit may get riper sooner and, as a result, could ripen during the warmer summer months, further amplifying the wine quality issues associated with a warmer environment.

Jones cautioned that increases in temperature would likely be accompanied by increases in humidity, and, therefore, disease pressure could be on the rise. Has anyone noticed that recently? I know that powdery mildew incidence and severity seem to be increasing almost every year, and I also have noticed higher humidity affecting stomatal conductance (higher humidity leads to higher stomatal conductance). Apparently, climate change has not led to overall increases in precipitation but has led to, and will continue to lead to, more dramatic weather events in the form of not only severe storms, but also intense cold, extreme heat and increased occurrence of drought. Although temperatures are rising globally, we don't talk much anymore in the vernacular of "global warming." Warming is certainly occurring, but it is the dramatic events occurring worldwide that are of greater environmental and societal impact. Hurricanes, fires, floods and other catastrophic events are beyond the scope of this discussion, but variable weather conditions are certainly impactful on wine growing.

References

³ Pathak, T., et al. Climate Change Trends and Impacts on California Agriculture: A Detailed Review. *Agronomy* 2018, 8, 25.

Prevent Powdery Mildew and Monitor Crop Water Stress in Real Time

Powdery Mildew Spore Traps and Fungicide Resistance Testing

- Weekly field testing of spore presence to forecast and optimize fungicide management programs
- Timely results direct more effective fungicide timing, chemistries and prioritize leafing schedules

Real Time Vineyard Water Stress Monitoring using Canopy Temperatures

- Know when water stress begins in real time and how much water to apply to maintain the desired plant water status.
- Real time soil moisture probes can be included in the CVC system.

Contact CVC for details

Bryan Rahn, Michael Princevalle office: 707.965.3700 info@coastalvit.com

www.coastalvit.com

Changes in weather from year to year are to be expected as a natural part of our wine-growing world and are often viewed as the primary influence of vintage quality. But as climate change intensifies, the variability from year to year increases, causing larger and larger deviations from the mean and potentially creating more and more poor vintages due to extremely cool weather or extremely hot weather. One does not have to look very far back to recall the 2017 growing season (very hot) followed by 2018 (very cool). The 2017 North Coast fires notwithstanding, 2017 was a difficult growing season that featured sluggish and stopped ripening due to sharp changes in temperature. Yes, weather varies, and much seasonal variability is simply natural changes in weather, but we will likely face greater variability as time goes on and climate changes worsen.

What Should We Do as Growers?

As climates warm and region II's get transformed into region III's (and so on), varieties that have performed well historically may not be ideal any longer. Jones said he is seeing that in the Willamette Valley, though they have some time to go before Pinot Noir doesn't work there. But, outside of the U.S., wine-growing regions in Europe and just northward into Canada have experienced such changes in climate as to consider varietal changes. For the Okanagan Valley of British Columbia, that means that Bordeaux varieties may be grown successfully in its southern reaches. That may be a welcome occurrence for them, though I know that there are very few who are actually excited about the prospects of climate change. Although research is ongoing to find alternative varieties for existing wine regions, how can Napa *not* be known for Cabernet Sauvignon? And who would want to see a Russian River Bordeaux blend? [Editors note: see *Technical Spotlight: Aperture Cellars*, page 36] Regions have developed identities, and a change in climate that upsets that identity could be a marketing nightmare and a real disruption to our industry—an industry that maintains deep ties to history and tradition. That said, it may be inevitable that some varietal changes be made, at least in the warmer parts of each region. In cooler parts of each region, warmer-climate varieties will likely begin their intrusion into formerly cooler-climate vineyards.

More subtle vineyard changes can be considered, especially in the cooler parts of each region that are not yet ready for varietal change. Trellis systems that provide more shade on fruit will likely become more popular, bucking the longer-term trend of strictly upright VSP trellises. Cross-arms to widen out those tight VSPs have been showing up more and more, though the benefit of widening the trellis has little effect on fruit shading unless row orientation is such that fruit becomes shaded during the hot, late-afternoon sun. Hence, vineyard design for new vineyards is as important now as ever—and likely more important. For existing vineyards, leaf removal practices may need to change, though the trend towards lighter leaf removal could potentially backfire into causing higher disease incidence. Plastic mesh shade cloth that covers the fruit zones from hot afternoon sun is becoming more common, and it seems that a black shade cloth, which provides about 30 to 35 percent shade works well in most cases over other colors and densities.

Irrigation management cannot be done by calendar or in the same manner every year. Rainfall patterns, especially spring rainfall in the North Coast, will dictate when irrigation needs to be started. Growers must look at weather forecasts to apply preemptive irrigations to avoid vine stress during heat waves. This is not that different than it ever was before, only it is more imperative than ever that growers stay on top of irrigation management and not follow the same pattern each and every year.

Wonderful nurseries™

WONDERFUL NURSERIES IS NORTH AMERICA'S LEADING GRAPEVINE NURSERY, FOR ALL THE RIGHT REASONS.

Quality

- 100% annual mother block testing
- ISO accredited in-house testing laboratory
- State-of-the-art facilities
- Eco-friendly processes

Service

- "Growers First" commitment
- Personal attention, with years of experience

- Shipping throughout the US and multiple International markets

Selection

- Largest selection of grapevines in North America
- Nearly 800 acres of isolated growing area for our mother blocks
- Regularly expanding our mother blocks to meet customer's needs

**ALWAYS RAISING THE BAR AT
WONDERFUL NURSERIES**



**SERVING YOUR VINE, ALMOND
AND PISTACHIO TREE NEEDS**



[WonderfulNurseries.com](https://www.wonderfulnurseries.com) 661.758.4777

P.O. Box 279, 27920 McCombs Ave., Wasco, California 93280

© 2020 Wonderful Nurseries LLC. All rights reserved.
WONDERFUL, WONDERFUL NURSERIES and the accompanying logos
are trademarks of Wonderful Nurseries LLC or its affiliates.

MicroVantage
Ultra Premium Filter Series

LET'S BE CLEAR

THE ANSWER IS MICROVANTAGE

When high purity & absolute retention are prerequisites for your filtration process,

MicroVantage cartridges deliver.

- > Membrane Cartridges
- > Melt-Blown Depth Cartridges
- > Pleated Filter Cartridges
- > Custom options available
- > Made in USA

SHELCO.COM

100 Bradley Street, Middletown, CT • info@shelco.com • 1.800.543.5843
ISO 9001:2015



Zenport
INDUSTRIES

Vineyard Tools

Pruning | Grafting | Tying | Harvest



Battery Powered Pruning Shears

- 1.25-inch and 1.5-inch cutting capacity models
- 15,000 pruning cuts per battery charge
- Includes lithium battery, harness, holster and carrying case



Grafting Tools



Harvest Shears

Tying Tools & Supplies

www.zenportindustries.com | 503-524-7289

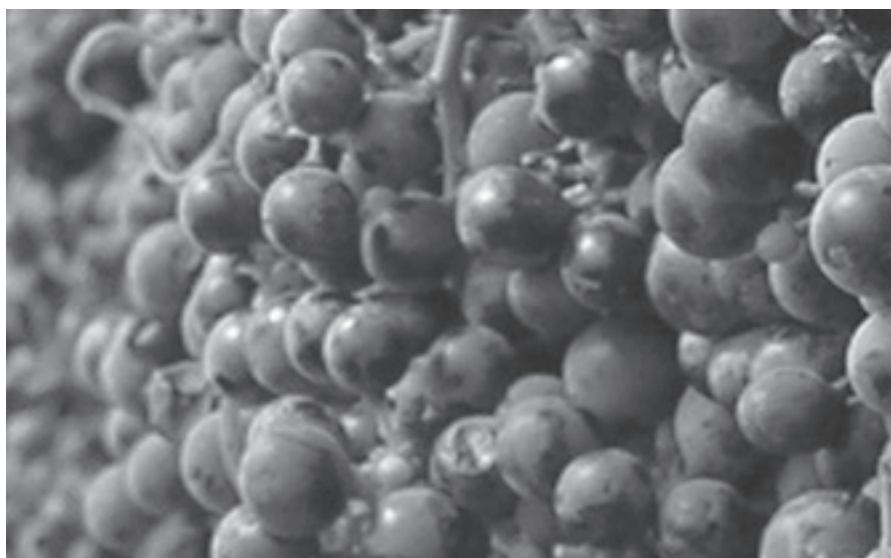

From Vine to Bottle

vineyard supplies & production equipment





When Quality Counts

Catalogs, videos & mfg. brochures:
SpecTrellising.com
800-237-4594

What Can Growers Do to Stop Climate Change?

We can't stop climate change; we can only slow it down. It will take dramatic shifts in our behavior and our reliance on fossil fuels to stem the tide. As individuals, the answer would be to initiate behavioral changes on a personal level, but that is of infinitesimal impact if not done broadly by the whole populace, not only by our country but by all countries, including those that are heavier contributors to GHGs than the U.S. So, yes, the answer is political, and it's not an ideological one necessarily (though it seems to be right now). There are members of all political parties who support changes to reduce GHGs, and they must be supported; they, in turn must support changes worldwide, including those bad actor countries that continue to emit GHGs at a higher rate than our own.

As for growers, our impact is slightly more influential than that of an individual outside the world of agriculture. We burn diesel to farm, burn vines and trees when they are removed for replanting, and we till the soil. All of these contribute GHGs to our environment and in a much bigger way than the average Joe.

I don't see us getting away from diesel tractors anytime soon. The amount of horsepower required for farming is high, and currently only diesel engines provide sufficient energy to run our implements. While the newer tiers of diesel engines are cleaner burning than they used to be, reducing particulates, carbon monoxide and oxides of nitrogen, they still spew about as much GHG as they used to; it's just that some of the other side-effects have been mitigated. I have yet to see an electric tractor in action, but they are on the way. About 10 years ago we would have scoffed at an electric car, but look at what we have now. Electric pickup trucks are on the way, and aside from the satisfying rumble of a full-size pickup truck, they will eventually be able to get the job done.

On the other side of the equation, vineyards sequester carbon, which is something we do that provides a benefit to the environment. Carbon is sequestered in the vines themselves but is also found in the soils where cover crops grow and decompose, leaving carbon skeletons that persist for long periods of time. The actual amount of carbon sequestered is now being studied in detail, and it is a meaningful amount. But we can quickly undo that benefit if we burn our vines after we tear them out for replanting. All of the carbon in the biomass of the permanent vine structure is released back into the atmosphere when vines are burned. Chipping is an alternative that avoids this rapid carbon release. It is considerably more expensive than burning, since wires and other hardware need to be separated from the vines instead of simply pushing them into a pile and burning. But its benefits should not be overlooked for sustainable, carbon-neutral winegrowing.

Perhaps even more detrimental than vine burning is tillage. Yes, good old tillage. While it seems logical to till a cover crop under to allow it to break down in the soil, tillage actually introduces a large slug of carbon into the soil that is rapidly decomposed, compared to the same vegetation in a no-till condition. Tillage destroys the soil structure and microbial ecosystem; it not only leads to a rapid release of CO₂ into the atmosphere, but also causes a large release of nitrous oxide. Nitrous oxide is a more detrimental GHG than CO₂. Reducing or eliminating tillage from our vineyards could go a long way towards improving carbon sequestration and GHG reduction.

While we represent only a small fraction of agriculture worldwide, wine-grape growers are dedicated to sustainability, and we can and should set examples for all of our agricultural brethren. True sustainability extends past one's own farm. **WBM**

Registration Open! | VineyardEconomics.com

Vineyard ECONOMICS SYMPOSIUM

The premier conference covering vineyard economic and financial issues.

May 6, 2020 | CIA at Copia, Napa

Vineyard Economics Symposium is presented by **WINE BUSINESS MONTHLY** and **WBMevents**

Thank you to our current 2020 sponsors!



For Sponsorship Opportunities, contact Waunice Orchid at 707-666-2525 or send an email to waunice@winebusiness.com



Sprayer Technology:

Every Drop to the Crop

Melissa Hansen and Gwen Hoheisel

Melissa Hansen is research program director for the Washington State Wine Commission, which works to make viticulture and enology research supported by the Washington wine industry more accessible to the state's growers and winemakers. Hansen was a journalist for nearly 20 years for *Good Fruit Grower*, a Washington-based magazine, and was involved with California's table grape and tree fruit industries for 15 years.

Gwen Hoheisel is a regional extension specialist with Washington State University, focusing on perennial fruit crops, and more specifically, sustainable pest management, blueberry horticulture and application technologies. She received a B.S. in Zoology from the University of Maryland and a Master's in Entomology from Pennsylvania State University, focusing on IPM and insect diversity.

GOOD SPRAY COVERAGE IS the foundation of effective vineyard pest management. Improper spraying can lead to significant crop loss from poor disease and insect control and off-target drift. Several vineyard sprayer technologies are available, each with different attributes. Understanding differences in sprayer technology can help you get the best performance from your sprayer and for your conditions.

The first step is to match the right sprayer technology to your canopy, management style and location. If you grow significant acreage of only grapes, consider a sprayer specifically designed for grapes because you will have fewer sprayer adjustments to make. Small growers with multiple crops should consider a sprayer that can adjust to meet the needs of all their crops.

Gwen Hoheisel, Washington State University (WSU) extension specialist, and Margaret McCoy, WSU Ph.D. candidate, led a sprayer assessment study to help winegrape growers better understand sprayers commercially available in Washington state, nozzle technologies and best management practices. Washington research dollars are from WSU, the Auction of Washington Wines, and all Washington state winegrape growers and wineries through the Washington State Wine Commission.

Key Points

- The easiest and most critical component to improve spray coverage is to ensure all sprayer parts are working properly. An annual maintenance plan is needed to check hoses, pressure gauge, rate controller, filters, tires and replace worn or clogged nozzles. Consider annual replacement of the pressure gauge and nozzles.
- If using a rate controller, annually check your ground speed (manually or with an independent GPS) to the speed registered on the rate controller. Differences in speed affect your rate (gallons per acre).
- Match sprayer to the needs of your operation—size, terrain, canopy shape and crops.
- The greatest return on your time and dollar investment for optimizing a sprayer and getting every drop to the crop (in order of importance) is to adjust the air volume to match the canopy, adjust the droplet size and adjust for weather (heat, wind and inversions).



Don't get caught short.

What's missing here? The glass!

As the largest glass distributor nationwide, we take the worry out of any short supply scenarios.

Run - Don't walk to your Saxco Packaging Specialist.

Visit us at saxco.com



Multi-fan, directional sprayer



Over-the-row, pneumatic or air-shear sprayer



Electrostatic sprayer



Axial fan or air-blast sprayer



Data were collected from three growing seasons (2016-2018) from four sprayer technologies:

1. Multi-fan, directional sprayer
2. Over-the-row, pneumatic or air-shear sprayer
3. Electrostatic sprayer
4. Axial fan or air-blast sprayer

The first three sprayer types were evaluated for spray deposition, in-field drift, disease control and best management practices. With the air-blast sprayer, different nozzle types and use with or without air assistance of the fan were studied.

The trial was a collaboration of growers and manufacturers. Field deposition measurements came from large commercial vineyard plots of 20 to 30 acres, with replication. Vines were trained to modified vertical shoot positioning (VSP) and strict VSP. The trial followed standards of the International Organization for Standardization (ISO). Treatments were applied on each side of a vine row, with samples collected in both early and full canopy over two seasons. Season-long spray programs were conducted to evaluate disease control and single-event sprays to measure field deposition.

Deposition was assessed by measuring the amount of a bright green, food-grade, fluorescent dye on 2-inch square cards placed in the canopy and on the ground, 1, 2 and 3 vine rows beyond the sprayer, and in the air, one, two and three feet above the canopy. Canopy deposition was divided into zones with three in the top of the canopy (only two with the strict VSP) and two on each side of the fruit zone.

The purpose of the research was to understand how to best use different spray technologies in Washington winegrape vineyards. It was not a sprayer comparison because the equipment was evaluated in different vineyards farmed under different viticulture management, and spray gallonage varied according to canopy volume, spray technology and weather.

Good News

Before the deposition trial started, each sprayer underwent maintenance and was calibrated—two steps that are often overlooked. Maintenance and calibration have significant effects on the quality of spray and deposition. Note that the percent deposition reported represents the proportion of the total that was collected, not the total mass from a sprayer, which was beyond the scope of this study.

For all sprayers, across all four years, a majority of the spray deposition that we collected—from 80 to 98 percent—was found in the sprayed vine row. This means that of all the deposition we measured on the cards from the locations mentioned above, in and under the canopy and several rows away from the sprayed row, a high percentage remained in the sprayed row. Additionally, in all vineyards, powdery mildew fruit ratings were minimal, indicating good control from all machines. Although we were rigorous about our assessments (30 clusters per sprayer and 50 leaves collected from the fruit zone and upper canopy), mildew pressure can fluctuate within a vineyard and among growing seasons, and it was promising to see relatively consistent control with each sprayer.

Overall, drift in the study was very minimal. The majority of deposition not in the sprayed vine row was collected one vine row from the target above or below the canopy even though cards were placed three vine rows over. When compared to what landed in the canopy, ground deposition was up to eight times less than the canopy, and aerial deposition was up to 400 times less. This showed that the four sprayer technologies, when well maintained and optimized for the canopy, perform well in Washington vineyards with minimal drift.

Vineyard canopies change during the growing season: There is less canopy to cover early in the season versus late in the season. Weather and temperatures also change throughout the season. Understanding your sprayer technology and the impacts that droplet size, nozzles, air and weather have will help you make adjustments to optimize your sprayer and reduce drift.

Matching Air to Canopy Volume

Many coverage problems can be solved by correctly matching sprayer air volume and direction to the canopy. Wherever air goes, spray goes. If you can see leaves and canes blowing around two to three rows from the sprayer, it means there is too much air, which will result in significant deposition on the ground between vine rows rather than on the canopy. Optimal air volumes and maximum deposition occur when the sprayer is calibrated to keep the air (and spray) within one vine row.

Adjustments were made to all four sprayers during the season to reflect canopy volume. The type of sprayer will dictate what adjustments can be made, such as position of fan heads to better target the canopy, using smaller fan size, closing or opening nozzles, using slower air speed, and gearing up, but throttling down, in order to maintain the same tractor speed while also reducing air volume by slowing the PTO (power take off).

Droplet Size Matters

Pressure, nozzle and tractor speed influence the application rate. Inaccurate pressure from a faulty pressure gauge or inaccurate speed from a faulty rate controller can result in the wrong gallonage application per acre.

Droplet size is determined by nozzle and pressure. Higher sprayer pressure results in smaller droplet sizes, which can sometimes increase control, especially in a contact pesticide. Smaller spray droplets can spread spray material over a large area—but smaller droplets increase your potential for drift.

Droplet size of less than 300 microns (a human hair is about 100 microns thick) tends to bounce off the leaf surface and results in off-target application. Droplets need to be small enough to stick on the leaves but not so big that only a few of them hit the leaf surface. The optimum size for most droplets to not drift or bounce is 150 to 300 microns. However, the chemical mode of action (contact, systemic or bait) and biology of the pest (stationary or mobile) must also be considered when determining an ideal droplet size.

Using air-induction nozzles can help reduce drift with large droplets that will remain on the target surface. Air-induction nozzles inject air bubbles into the liquid droplets, resulting in a coarser droplet that splatters upon contact. Air-induction nozzles are manufactured for both canopy and weed applications. For canopy deposition, it is more common to use one-piece nozzles, such as Teejet VisiFlo, that produce “very fine” droplets (61 to 105 microns).

But based on prior research that showed minimal drift and good control with air-induction nozzles in air-blast sprayers, we have ongoing trials to look at coverage comparisons of one-piece and air-induction nozzles used through the grape growing season and with different settings on an air-blast sprayer. Using air-induction nozzles for a weed sprayer is a good choice to reduce herbicide drift. Even though many herbicide labels are now listing requirements for larger droplets, it is important to check the label to ensure there are no special restrictions on applying larger droplets.

Drift is difficult to control in windy locations when using fine droplets. One solution for sites where winds are routinely 10 to 15 miles per hour is to use a larger nozzle size and a sprayer that pushes the air into the canopy on opposing sides, such as over-the-row technology and tunnel sprayers.

Adjustments for Weather

When fine droplets are sprayed under hot, dry conditions—around 85° F and above—evaporation can occur so quickly that the droplets reduce in size, making them more prone to drift and never contacting the canopy target. Drift can also increase in windier conditions—we have seen on all the tested sprayers less deposition on canopies when wind is greater than 6 miles per hour.

The easiest solution to adjust for wind and heat is to make a management decision to change the time of spraying to lower the peak spray temperature. We also advise that if your sprayer allows, change the droplet size by going up one nozzle size to create larger droplets. In axial fan and multi-fan sprayers, different sizes and types of nozzles can be used. In other sprayers, like the pneumatic and electrostatic sprayers used in this study, nozzles are not interchangeable. If that is the case with your sprayer, spraying at lower temperatures is your only option to reduce evaporation and drift.

Spray On. Birds Gone.



Spraying Avian Control replaces netting for a fraction of the cost.

Without Avian Control® we would clearly need to net our vineyard. Avian Control® allows us to get our grapes to full ripeness. Providing us the flexibility to leaf pull and hedge right up to the very end.

—Jack Tomasello, Tomasello Winery, Inc., Hammonton, NJ

Avian Control®
Liquid Bird Repellent

Call Today For More Information

888-707-4355

Sales@AvianControl.com • www.AvianControl.com

WE'RE WINERY TANK SPECIALISTS

New European Quality Winery Equipment



Letina & BSV Tanks



**In Stock • Ready to Ship
Located in Portland, Oregon**



bsvtanks.com | 503-780-4681



Multi-fan, directional sprayer



QUANTUM MIST

LEFT: Quantum Mist is a multi-fan directional sprayer for more than one vine row with adjustable heads to target spray into the canopy and adjustable fan speeds to match air volume to canopy density. The fan heads have exchangeable nozzles to allow for customized applications.

RIGHT: The Quantum Mist technically has a nozzle body that can accept a variety of nozzles, but the manufacturer suggests the use of Visiflo or similar nozzle that produces fine droplets. The ceramic parts of this nozzle will decrease wear or degradation of the nozzle within the growing season.

Multi-fan, Directional Sprayer

A Quantum Mist machine was used in this study to evaluate the multi-fan, directional technology. These sprayers have low air volume, and opposing fans are designed to minimize drift and keep spray within one vine row. We studied a three-row machine with 12 fan heads aimed at the canopy and placed about 24 inches from the canopy per manufacturer recommendations.

Canopy deposition with this technology was high, with 95 to 98 percent of the collected deposition going into the canopy. It is important to note that these depositions are a percentage of the total collected as opposed to an analysis of total volume emitted from the sprayer. In both years and times of the study, more deposition was observed in the upper zone of the canopy compared to the lower fruit zone, which we believe is because the fruit zone has far less leaf density and canopy to catch the spray compared to the upper region.

While the fans on multi-directional sprayers have an adjustable speed, they are all adjusted simultaneously. Operators could better match the air volume to the canopy if the sprayer offered independent control of upper and lower fans.

Follow these tips to optimize multi-fan sprayers:

1. Check fan alignment at every tank fill. Fans can be knocked out of place when turning vine rows. Fans should be angled into the canopy but also slightly backwards.
2. Replace broken fan blades. Nicked, bent or broken blades impact air volume and patterns of air.
3. In early season, we used only four nozzles to reduce the gallons per acre (GPA). Nozzle placement should be symmetrical around a single fan (two on top, two on bottom)—not in a row, as this will affect the spray pattern and lead to more streaks. When there is minimal canopy focused just around the cordon, consider using only the bottom fans or reducing the fan settings so less air volume is produced.
4. Verify speed of the rate controller annually by either measuring it with an independent GPS or calculating miles per hour by timing an 88-foot course (1 mph per 60 seconds traveled). In Washington, the manufacturers of Quantum Mist use a rate controller where speed is measured by GPS. Make sure the GPS is mounted in a location with unobstructed parallel “view” of the sky.

Over-the-row, pneumatic or air-shear sprayer



GREGOIRE

LEFT: The Gregoire air-shear sprayer has pneumatic nozzles and flexible wind socks aimed into the canopy of more than one vine row. Sections of nozzles can be turned on or off depending on canopy density.

RIGHT: The DynaDiff diffuser nozzles on Gregoire sprayers are pneumatic, which means fine droplets are created by high speed air cutting the stream of liquid exiting the nozzle. They generally do not need to be replaced, but some parts of the nozzle body will need maintenance.

Pneumatic, Air-Shear Sprayer

In this study, we evaluated a three-row machine with six inflatable windsocks manufactured by Gregoire. Windsocks should be situated 18 to 24 inches from the canopy and aimed slightly backwards and into the canopy. Each sock had five pneumatic nozzles that emitted “very fine” droplets (61 to 105 microns), which can be turned on or off in sets of two or three nozzles. In the early season, we raised the entire boom and used only the lower three nozzles aimed at the cordon. Later in the season, we lowered the booms and used all five nozzles.

The rate controller in this machine regulates gallons per minute and verifies speed with a wheel sensor. This sensor is affected by tire pressure and size and should be checked manually once per year and adjusted, if needed, to deliver the desired gallons per acre.

Like the multi-fan, directional sprayer, this technology is designed to use low air volume and direct spray into the canopy to minimize drift. Canopy deposition was high—97 percent of the collected deposition went into the canopy in both early and late season measurements. In the early season, by using three nozzles, more deposition was directed near the cordon; in the late season, a more even distribution was measured between the upper and lower zones.

However, in the first year, there was more deposition (about 75 percent) in the upper canopy, which matched the pattern for the multi-fan sprayer in the first year. The annual differences could be due to different sprayers or adjustments.

Operating tips for pneumatic sprayers include:

1. Check rubber gaskets at the check valve and replace annually.
2. Tighten bolts at the nozzle head and check with every tank fill. Newer models have changed the connection at this point, but it is still good to examine regularly.
3. Align windsocks toward the rear of the sprayer and into the canopy and check at each tank fill.
4. Tubes leading to nozzles are small and can get clogged with poor operation and/or a poor cleaning routine.
5. The tubing can be switched to use three nozzles in early season, five in late. Adjust based on the canopy height so that you can use the appropriate nozzles without the socks dragging on the ground.
6. Verify speed of rate controller annually as described with the multi-fan. The manufacturers in Washington use a rate controller with a wheel sensor so changes in tire pressure or size can affect the measurement of speed.

Electrostatic sprayer



ON TARGET

LEFT: On Target electrostatic sprayers can be single or multi-vine-row and have low air volume targeted to modern, high density canopies. Droplets are charged before leaving the nozzle body which aids in attracting droplets to the canopy.

RIGHT: The On Target electrostatic nozzle has a rubberized outer cover that protects the internal components that induce the charge on the droplet. These nozzles produce fine droplets and typically only need gaskets replaced periodically, as opposed to the entire nozzle.

Electrostatic Sprayer

A two-row machine was used with eight tubes located 24 to 30 inches from the canopy. The sprayer was manufactured by On Target Spray Systems. Each tube had five nozzles that emitted “very fine” drops from 61 to 105 microns. This electrostatic sprayer produces low volumes of air that propel charged droplets into the canopy, which are attracted to the opposite charge of the plant surface. The smaller the droplet, the stronger the charge.

This machine is designed to run at a low volume (approximately 20 gallons per acre) to ensure small droplet size. The charged droplets do need to be within the 24- to 30-inch sprayer range of the plant. A benefit of the On Target design is that it can be adjusted to be directly sprayed onto the cordon or canopy, and the volume of air is well matched to the size of the vine canopy.

Canopy deposition with the electrostatic sprayer was high, with 92 percent collected for early season and 80 percent collected in late season. We believe that a large contributor to the differences in deposition between early and late is due to environmental conditions during operation. Although within ISO standards, the average wind speed was different for the early and late season measurements (1.1 mph for early and 6.6 mph for late), and the temperature was 7 degrees warmer.

We specifically wanted to note the interaction of weather and droplet size as all four machines studied have nozzles that can produce very fine droplets and all the machines have shown more drift in windy and hot conditions. Very fine droplets will evaporate and drift more under these conditions, and it is important to make management decisions, when using any of these sprayers, to not operate in wind and higher heat.

To get the best performance from an electrostatic sprayer, follow these tips:

1. As part of an annual maintenance plan, use a voltmeter to check voltage at nozzle tips, as well as inspect and replace, when necessary, rubber gaskets and hoses.
2. Adhere to the maximum GPA for your specific electrostatic sprayer. Higher gallonage can result in larger droplets with a weaker charge.
3. Cleaning and maintenance are key to proper operation. On Target sprayers have built-in rinse tanks for quick and easy rinsing.
4. Spray must be directed at the canopy. Adjust spray arms appropriately and check at every tank fill. Newer sprayer models allow arms to be moved horizontally to direct spray onto the cordon, a benefit for early season applications.

Axial fan or air-blast sprayer



REARS MANUFACTURING CO

LEFT: Rears air-blast sprayers cover one side of two vine rows on left and right in this photo taken in early- to mid-season. They use interchangeable nozzles that allow growers to customize the droplet type and size at each nozzle body. This ability makes them highly adaptable to many canopy shapes and sizes.

RIGHT: An air-blast nozzle can use a variety of nozzles including disc-core, air-induction, or Visiflo (see photo). This allows for the largest range of droplet sizes that are determined by orifice size and pressure. The Visiflo nozzle uses a single, color-coded body allowing for easy identification and replacement. The internal ceramic parts are the hardest material and increase the life of the nozzle.

Axial Fan Sprayer

Air-blast technology, though not designed specifically for vineyards, is still the most used sprayer in specialty fruit and nut crops, according to previous WSU grower surveys. As with any sprayer, determining nozzle type and appropriate air volume for the canopy is critical to minimize drift and maximize deposition. Air-blast sprayers are very versatile, allowing different nozzles and arrangements. The air-blast sprayer used in this study was manufactured by Rears Manufacturing Company.

While it is still common to use disc-core nozzles, air-induction and hollow-cone, ceramic one-piece nozzles (such as Teejet VisiFlo), are adequate alternatives. The ability to vary droplet size through nozzle selection is an advantage of sprayers with exchangeable nozzles. We have on-going studies to evaluate these nozzles, as well as air-on/off in Washington vine canopies. However, the greatest impact on canopy deposition with air-blast sprayers is matching air direction and volume to the canopy.

Tips to adjust air in the axial fan sprayer include:

1. Hold a stick with flagging at each nozzle to visualize where air is moving. Open only nozzles that have air directed into the canopy.
2. Try to keep air within one vine row by changing the gear on the fan from high to low, changing to a smaller fan or using gear-up and throttle-down (GUTD) technique. The smaller fan and GUTD generally have the greatest impact on air volume.
3. To achieve GUTD, find a higher gear that allows you to maintain the same speed while changing your throttle to a lower position. By reducing the throttle, you reduce the PTO speed, slow the fan rotation and produce less air volume. Many tractors display the PTO speeds with a mark for 540 and 540E while others only mark the engine speed (example: 2400 or 1900). If you can reduce the throttle to 540E or equivalent engine speed, it will help you match the volume of air from the sprayer to the grape canopy. Remember, wherever air goes, droplets go.
4. As discussed previously, follow a detailed maintenance plan to ensure proper functioning of the pump, hoses, pressure gauge and nozzles, as these all affect droplet size and rate.

More information about axial fan sprayers can be found at: sprayers101.com and *Effective Vineyard Spraying: A Practical Guide for Growers* by Andrew J. Landers (2010).

Optimizing Sprayer Performance

As the growing season warms and vine growth takes off, it is difficult to keep up with powdery mildew and other fungal disease applications and keep rapidly growing plant tissue protected. If you are having trouble staying on top of disease management, consider purchasing another sprayer or go to a multi-row sprayer.

Based on a previous study of sprayer economics,¹ it pays to spray more vine rows per tractor pass. Of all the changes in spray practice and equipment, the greatest savings occurred by changing from one to two vine rows sprayed per tractor pass, which saved \$9.60 per acre per spray. (TABLE 1) Other ways to shorten your spraying time without compromising spray efficacy are to increase tank size and decrease spray volume (within reason).

TABLE 1 Getting more out of your sprayer

Changes in spray practice or equipment	Savings/acre/spray
One to two vine rows sprayed per pass	\$9.60
Increase tractor speed (2 to 4 mph)	\$4.50
Increase tank size (200 to 400 gallons)	\$1.40
Decrease spray volume (80 to 40 GPA)	\$0.60

NIEDERHOLZER, F.

Unveil the exceptional

Your wine deserves a distinctively elegant bottle.

Our bottles open up a world of possibilities!

An exceptional array of classic, modern and creative models, high-quality glass and longstanding expertise: let us help you choose the perfect bottle to showcase your product.

UNITED BOTTLES & PACKAGING

1 877 762-1867

unitedbottles.com

There is no perfect spraying machine. All can be operated well or poorly. But as this study showed, sprayers that are well-maintained and optimized beyond basic calibration practices for the canopy performed very well with minimal drift and provided good disease control.

Although each machine operates differently, it is always important to read and follow pesticide label directions for rates and droplet sizes.

WBM

References

¹ Niederholzer, F., et al., 2013. Cost Saving Practices Ranked for Grape Spraying. White paper and Growing Produce.



A Well-Paired Power Solution

Winemaking pairs best with power that stays on. When **PSPS** events or other natural disasters strike, PowerOn Solutions is the only power generation partner you need. Visit www.poweronsolutions.com and learn how we provide the support engineers, installers, and technical support specialists to meet your unique needs.

contact us at 916.806.8600 | sales@poweronsolutions.com

P  **W E R**
N WE KEEP THE
POWER ON

Sudden Vine Collapse May Be Associated with Combination of Virus Pathogens

Lodi Meeting Updates Growers on Recent Research

Ted Rieger



TED RIEGER

A Cabernet Sauvignon vine on Freedom rootstock in a 25 year-old Lodi vineyard displays sudden vine collapse symptoms from collapse during the 2019 growing season.

MYSTERY (OR SUDDEN) VINE COLLAPSE was first reported by winegrape growers in the Lodi AVA in 2011. Today, it's found in other grape-growing regions throughout California as well, and the cause may be associated with a combination of virus pathogens, including leafroll virus and grapevine vitiviruses. It appears that certain rootstocks, notably Freedom and perhaps others, are more sensitive to these virus combinations and, thus, more prone to vine collapse.

During an Oct. 1, 2019 meeting, the Lodi Winegrape Commission (LWC) presented an update on recent research on sudden vine collapse and lab results of tested vine samples from Lodi vineyards where vine collapse has occurred.

Background and Vine Collapse Symptoms

Since 2011, growers in the Lodi AVA have reported individual or small groups of vines on Freedom rootstock collapsing, or suddenly dying, without being able to determine a definite cause. Some growers reported 30 percent of a vineyard block collapsing within two years. By 2018, the vine collapse reached an economic threshold of destruction, affecting enough growers financially (more than 20 within the Lodi region) to gain more attention.

Dr. Stephanie Bolton, LWC grower communications and sustainable winegrowing director, said, "At least three entire blocks were ripped out because of this, and more will follow this winter. I have a growing list of approximately 30 vineyard blocks to include in our case studies from Lodi and beyond."

Bolton listed the following symptoms of vine collapse, as observed in Lodi:

- Vines may show stunted shoots May through July, growing to less than half the size of healthy shoots.
- Many vines push out fruit and then collapse.
- Collapsed vines lack feeder roots.
- The entire vine goes from having green shoots to being completely dried up rather quickly (typically in two to six weeks).
- The symptoms look similar to *Eutypa* dieback, but vine death is more rapid and without cankers.
- In many cases, the graft union appears rotten; and when the trunk is sawed at the junction, dark, necrotic tissue is visible.
- The patch of collapse in a block can tend to spread in the direction of the wind and in a rough circular shape, which can be seen in Google Maps once it gets large enough.

Cases of sudden vine collapse have also been observed in vineyards in Stanislaus County and in vineyards in the Central Coast counties of Monterey and Santa Barbara.

Ted Rieger, CSW, is a wine journalist based in Sacramento, California and has been a writer for wine industry media since 1988.

SUPPORT RESEARCH & WINE INDUSTRY NEEDS THROUGH THE
AMERICAN VINEYARD FOUNDATION



Finding Solutions Through Research

INVESTIGATING INNOVATIVE VIRUS DISEASE MANAGEMENT STRATEGIES

Dr. Fuchs proposes to develop RNAi constructs that will provide resistance to fanleaf virus or to GLRaV-3 (leafroll) infection (and grape mealybug feeding) in grapevine. Also, with funding provided by the Pierce's Disease GWSS Board, Dr. Fuchs will extend his research monitoring the spread of GRBaV (Red Blotch), continue to identify GRBaV vectors and focus on the development of improved GRBaV diagnostic techniques. For more information, visit AVF.org or contact Dr. Fuchs at mf13@cornell.edu.

For a wealth of useful viticulture and enology research and information, visit AVF.org, ngr.ucdavis.edu, asev.org, iv.ucdavis.edu or ngwi.org

AMERICAN VINEYARD FOUNDATION

P.O. Box 5779, Napa, CA, 94581 • tel (707) 252-6911 Visit our Web site at www.avf.org for information on funding and current research projects



Gomberg, Fredrikson & Associates

Market Intelligence for the Wine Industry



We perform extensive market research and data collection to create the wine industry's leading shipping, pricing and market reports; helping sales and marketing teams make informed business decisions.

PRODUCTS

Gomberg-Fredrikson Reports

The Executive Market Reports of the Wine Industry put your business in context among current wine industry market trends.

Price Service

Competitive supplier pricing for more than 20,000 products. Featuring an interactive tool that allows you to create your own pricing report from the entire wine pricing database.

Price Analysis Report

Highlights of the Price Service data help subscribers identify industry trends and market shifts by region and wine variety.

Vine Sample Lab Testing Results

Dr. Maher Al Rwahnih, UC Davis (UCD) Foundation Plant Services (FPS) plant virologist and lab director and academic administrator, presented results of lab testing for virus infections from vine samples collected from four Lodi vineyards on July 18, 2019. Rwahnih's lab processed 24 samples by using high throughput DNA sequencing to test for viruses of known agronomic significance.

Samples of both rootstock and scion tissues were collected and processed separately from three vines, each in four different vineyards that showed symptomatic vines. The four vineyards ranged in age from six to more than 25 years old and included a vineyard planted in 1993 with Cabernet Sauvignon on Freedom rootstock, a vineyard planted in 2013 with Pinot Noir on Freedom and two different vineyards with Chardonnay on Freedom.

Symptomatic vines tested positive for grapevine leafroll-associated virus 3 (GLRaV-3), and many were also co-infected with one or more viruses from the genus *Vitivirus*. Five vitiviruses have been known and identified for some time, and FPS tests for these known vitiviruses: grapevine virus A (GVA), GVB, GVD, GVE and GVF. Some of these vitiviruses are associated with rugose wood complex diseases. In grapevines these viruses can cause corky bark, stem pitting and grooving under the bark, swelling at the graft union and stem cracking.

A research paper coauthored by Rwahnih and other UCD colleagues published in 2018 in the *European Journal of Plant Pathology*,¹ "Synergy between grapevine vitiviruses and grapevine leafroll viruses," suggested the potential for a synergistic enhancement of grapevine disease in co-infected vines. This paper's abstract states: "An interactive relationship between vitiviruses and grapevine leafroll viruses was characterized in grapevine. Grapevine viruses A and B (GVA and GVB) were found more frequently in the presence of co-infecting Grapevine leafroll associated viruses (GLRaV-1, -2 or -3) than in their absence. The titers of the vitiviruses in co-infection with leafroll viruses were found to be higher than were their titers in the absence of leafroll virus infection. The occurrence of vitivirus-associated stem-pitting symptoms was correlated with leafroll virus co-infection. Specific pairing associations on the species level were found between different viti- and leafroll virus species: GVB was associated preferentially with GLRaV-2; GVA was associated preferentially with GLRaV-1 and GLRaV-3."

Rwahnih also cited a recent research paper in the journal, *Archives of Virology*, July 2019, with FPS director Dr. Deborah Golino as a co-author, that identifies and names five new vitiviruses—GVG, GVH, GVI, GVJ and GVL.

Rwahnih also discussed the concept of virus-induced rootstock decline (VIRD), investigated by Golino and UCD colleagues, that showed the combination of GLRaV-2 and GVB leads to severe stunting on Freedom rootstock. This work supports the hypothesis that rootstock response to virus infection depends on the rootstock genotype and the virus type. More information on this can be found in a paper co-authored by Golino available at iv.ucdavis.edu/files/108796.pdf.

In addition, some Lodi vine samples tested positive for viroids—the smallest infectious pathogens known. Viroids are smaller than a virus, consist solely of a single strand of RNA and can cause disease in certain plants.

Fungal Pathogen Testing

Dr. Akif Eskalen, UCD plant pathologist and UC Cooperative Extension specialist, sampled scion and rootstock tissues for fungal pathogens from the same Lodi vines collected on July 18. Testing revealed a number of fungal pathogens common in grapevines (*Eutypa dieback*, *Botryosphaeria dieback*, *Phaeoemiella chlamydospore* and others), but no consistent single fungal pathogen was found among all vine samples.

According to Eskalen, "Grapevine trunk diseases, including Esca (measles) and Bot canker, have been known to cause apoplexy (sudden vine collapse) on grapevines in California and in other grape growing areas of the world. However, in this case, interactions between GLRaV-3, GVA, grapevine trunk diseases and also *Fusarium solani* (a common soil and plant fungus) may play a role in the sudden vine decline that we have seen in San Joaquin, Stanislaus, Monterey and Santa Barbara counties so far."

To date, only samples collected from vines on Freedom rootstock have gone through comprehensive lab testing. The researchers believe other rootstocks, such as Harmony, may also be susceptible to collapse. The researchers have not seen evidence of differences in susceptibility based on the scion variety.

At this time, advice to growers for managing sudden vine collapse is similar to management of leafroll viruses in general: reduce and control spread of mealybug vector populations and reduce and eliminate virus inoculum by rogueing infected vines.

Future Research Plans

Future research on sudden vine collapse will continue to collect case studies, test vines at collapse sites to further determine the cause, elucidate risk factors, investigate possible relationships between co-infections of leafroll viruses with vitiviruses, and identify the susceptibility and resistance of specific rootstocks to collapse.

The LWC will continue to study the issue, pursue research funding, monitor vineyard sites, provide grower outreach and develop management strategies. Growers who believe they have observed sudden vine collapse in their vineyards are encouraged to contact Dr. Bolton (stephanie@lodiwine.com) to report their experiences and be added to the case study list. **WBM**

References

- ¹ Rwahnih, A., Daubert, S., Arnold, K. et al. *Eur. J. Plant Pathol* (2018) 151: 919. <https://doi.org/10.1007/s10658-018-1426-7>

Marketing and Security Drive NFC-enabled Innovation

Vendors incorporate the technology into their packaging suites while wineries take note

Erin Kirschenmann

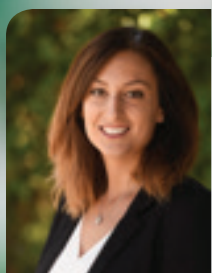

Erin Kirschenmann is the managing editor for *Wine Business Monthly* and has been with the company since 2012. In addition to production responsibilities for the monthly trade magazine, she writes about wine industry trends, including business, technology, sales and marketing topics, and oversees content for *WBM*'s eight conferences. She has spoken on industry trends at numerous conferences, including the Unified Wine & Grape Symposium and the World Bulk Wine Exhibition and guest lectures on wine, media and public relations. Erin has served as a judge in the *Concours Mondial de Bruxelles* since 2016 and at the *Central Coast Wine Competition*. She earned her Bachelor of Arts from Sonoma State University in communications with a journalism emphasis.

AS A PRODUCT TYPICALLY driven by tradition and heritage, wine isn't the first alcoholic beverage many would consider to be innovative in its packaging. Rather, stereotypical images of glass bottles, natural corks and chateau-adorned labels immediately come to mind. While the use of new materials, like cans, is something that has only recently become more acceptable for more than just bargain brands, there are some companies that made the move toward alternative and more sustainable materials sooner than others—and they're being rewarded for it in the marketplace.

Now, even though new packaging technologies have become available, wine brands aren't as active in applying these tools as, say, their spirits or consumer packaged goods (CPG) counterparts. Part of the dilemma was that, for a long time, the technology was more expensive—there just weren't many affordable, reliable options. But today, beverage alcohol brands are able to take advantage

of new products and methods, at a much more palatable pricepoint, that solve a multitude of problems, including collecting consumer data and ensuring the legitimacy of the product, and at the heart of those solutions is near field communication (NFC).

The use of NFC-enabled packaging in the beverage alcohol space is growing, albeit off a small base, as wine and spirits companies look to build bridges that lead directly to their drinkers. For those brands with heavy retail presences, NFC-enabled capsules, corks, screw caps and labels have provided the opportunity to circumvent on-premise gate-keepers and engage with the end consumer one-on-one to tell a brand story. For those utilizing a more direct-to-consumer model, NFC facilitates an easy interaction that builds upon the tasting room experience and keeps club members connected—much more so than simply receiving and opening shipments.

Die-cutting made easy

Use a screen printed label.

Let us show you how.

monvera

Glass Décor

monvera.com



RICHMOND, CA 877.792.1150
NAPA, CA 707.271.6455

What is NFC?

NFC has played a part in many consumers' daily lives. It fuels Apple Pay and Google Pay, and many credit card companies have issued cards that require just a tap against a payment reader. NFC is a way to wirelessly transfer data by enabling two devices embedded with NFC chips placed within centimeters of each other to communicate and share information (such as credit card numbers or images) through a wireless link. Because it is such a low-power technology, it does not require a unique link or pairing code. It's a natural evolution from radio frequency identification (RFID) into a much simpler and faster method of data transfer.

In a wine industry marketing example, the NFC chip-enabled devices most often discussed include closures, capsules or labels, as well as the consumers' smartphones. Until now, however, the technology has most frequently been used by wine and spirits companies as an anti-counterfeiting measure.

“By transforming the one asset Malibu knows its consumers come into contact with, we're able to connect with our target audiences on a much deeper level, through the experiences we offer.”

-Caitriona Murphy, global brand manager, Malibu Rum

Anti-counterfeiting and Other Security Measures

Anti-counterfeiting measures themselves are not a novel concept in wine, though the use of NFC chips as a tool to do so is relatively new.

For more than a decade, there have been measures security-conscious designers and brands could take to ensure that the wine bottles collectors held in their hands were real, and those measures worked in much the same way the United States Treasury employs special inks and holograms to fight counterfeiting. AV Unique Label from Authentic Vision uses QR codes and holograms on labels; ProofTag uses translucent polymers, QR codes and a datamatrix on a strip that would be applied to the neck and foil of a bottle; and SICPA offers a range of similar products.

At the outset, these were the solutions for high-end, rare or cult brands that dealt with collectors, auction circuits or overseas buyers. Revenue loss was an obvious reason for the measures, but damage to a brand from subpar wine was the bigger threat.

Today, more producers outside the collectors' sphere look to prevent potential harm to their brand's images and are proactively turning to new, more secure, packaging solutions to thwart the risk.



One of the first NFC-focused products launched widely in the United States was InTact, a smart capsule created through a partnership with packaging manufacturer Amcor and Belgium-based marketing company Selinko in late 2016. InTact takes advantage of some key security features inherent to the NFC technology: it can monitor the location of the bottle from winery to warehouse and from the warehouse to its final destination—the retailer and/or end consumer. It can also detect whether the capsule has been removed or damaged, thereby stopping potential counterfeiters from opening and drinking, and then re-filling, re-sealing and re-selling that bottle with cheaper, lower quality wine. An NFC chip also offers one other obvious additional security advantage: it cannot be replicated as easily as the highly-visible QR code.



Since the launch of InTact, several product manufacturers have gone a step further and launched products that incorporate the chip into the closures themselves, and wine and spirits brands are taking note.

In the spirits world, counterfeiting has become a problem, particularly in some of the fastest-developing spirits markets of Eastern Europe, Asia, Latin American and Africa—a recent Euromonitor report estimated that 30 to 50 percent of all alcohol sales in Russia are actually illicit vodka. With this data in mind, savvy producers are increasingly implementing measures to stop potential imitators in their tracks.



In early 2019, Corticeira Amorim, one of the leading natural cork suppliers, launched its Tap Series, a range of bartop cork stoppers for spirits brands to help in the fight against this particular threat. According to Amorim, embedding the chip within cork itself adds an extra layer of protection that makes harder for thieves to operate—because cork is not a natural, local product where counterfeiting is strongest, it cannot be easily, or cheaply, sourced.

Guala Closures Group also jumped into the NFC game with the debut of its Nestgate range of NFC-enabled closures in summer 2019, featuring seven caps for wine, spirits and olive oil.

Vigneti Massa, a wine estate in Italy's Piedmonte region, saw the benefits of NFC technology, and uses Guala's closures in conjunction with a blockchain platform produced by Luxembourg-based software company Compellio to provide unique identification codes for every bottle, ensuring traceability of bottles along the supply chain.

Walter Massa, joint owner of Vigneti Massa, will launch the cap with the 2018 vintage. “One phenomenon that is not talked about much is the counterfeiting of great wines,” Massa said in a statement. “The NFC system guarantees the fight against counterfeiting and the ‘black market’ for these pearls of nature, assuring their authenticity and traceability.”



NĚSTGATE™

CONNECTED CLOSURES

Get closer to your consumers



NĚSTGATE: it's all in the name. A comprehensive range of connected caps with the power to open doors to new and exciting digital relationships between brands and consumers.

Discover our range of connected closures for wine, spirits and olive oil on www.nestgate-gualaclosures.com or contact us at Email info@gualaclosuresNA.com | Tel +1 707 425 2277



**WORLDSTAR
WINNER 2020**

 *Guala Closures North America*

Moving from Anti-Counterfeiting to One-on-One Conversations with End Users

While theft prevention is critical, a few wine and spirits producers have picked up on the marketing implications of NFC technology as well. By teaming up with software companies that connect bottles and content to the Internet of Things, brands are able to transform traditional packages into lively and experience-based tools. Unique coupons and access to wine club-only offerings, as well as content related to the production of the liquid inside, are only a few of the ways that a handful of wineries around the world have made the most of the software.

When Amcor and Selinko first launched InTact, one of the highlighted benefits of the capsule was that ability to connect a product to the Internet of Things, without the hassle. A consumer need only hover a smartphone near the capsule and brand-generated content would appear on-screen—and it didn't require the consumer to download a separate app. It was a simple, non-obtrusive way to start a relationship with a wine drinker.

This feature encouraged brands using the platform to step up efforts and do more than simply drive customers to the website. Instead, strategic marketing and collecting consumer insight became the focus.

NFC chips are often provided unique identification numbers, which foster the use of geolocation, allowing interested brands to collect data to better understand which cities and retail locations its most engaged consumers are living and shopping. Emboldened with this information, targeted marketing in the right regions and among the right demographic groups could lead tactical product teams to stronger sales.



Copper Cane Wines & Provisions was the first U.S. winery to implement Guala Closure's e-Wak NFC aluminum closure and use it for its Böen brand. As most bottles of this brand are sold in outlets other than its own website and tasting room, Copper Cane needed a way to connect and engage with potential customers earlier in the purchasing process to drive home the initial purchase and further sales.

Those interested in Böen need only follow the "Tap our Cap" instructions (shown on the top of the cap and on a callout collar) to be transported to a website that features imagery of the winery's vineyards and farmhouse. Through the site, Copper Cane offers more information about how and where the wine was made, food pairings, and a social media element with a hub for drinkers to share their experiences with the brand. The technology for e-Wak was developed by Guala and SharpEnd, an agency that works with fashion, spirits, food and other CPG brands to connect packaging, retail and experiential activity.

In Italy, Massa is also using Nestgate NFC-enabled closures as more than a security measure. Massa's consumers tap on the wine's cap and are taken to a portal to create their own virtual cellars, as well as find more information on tasting notes, reviews, and vineyard and winery specs.

Pernod Ricard also used the Nestgate line for 300,000 limited-edition bottles of its popular Malibu rum to support The Malibu Games, a marketing campaign that encourages its drinkers to become the "global icon of summer."

"Malibu has transformed its bottles into media touchpoints, allowing conversation in a space that is notoriously saturated," global brand manager Caitriona Murphy said. "Our bottles with connected closures help keep the brand relevant post-purchase, providing services and experiences to the consumer beyond the liquid itself. By transforming the one asset Malibu knows its consumers come into contact with, we're able to connect with our target audiences on a much deeper level, through the experiences we offer."

Audiences in Texas and Ohio, where the special bottles were distributed in the summer of 2019, were able to access exclusive content related to The Malibu Games and join in by playing a mobile game called Sunshine Slide. If players did well, they could win prizes and, thus, the spirits brand gamified the relationship between rum and drinkers.

Brazilian cachaca producer Cana is using Amorim's Tap Series to help connect to its community of drinkers while better understanding consumer behavior patterns—a feat typically hindered by the nature of the three-tier system. With its app, the spirits producer facilitates a continued connection after the drink with reward tokens (another method of gamification) awarded for engagement, authenticity verification and a social platform.

NFC technology is not just confined to closures and capsules, either. BottleVin, Inc., a marketing and analytics platform, is incorporating NFC chips into its labels, and many of its winery clients, including Reynolds Family Winery, Balboa Winery and Bricoleur Vineyards, are taking advantage. [WBM](#)

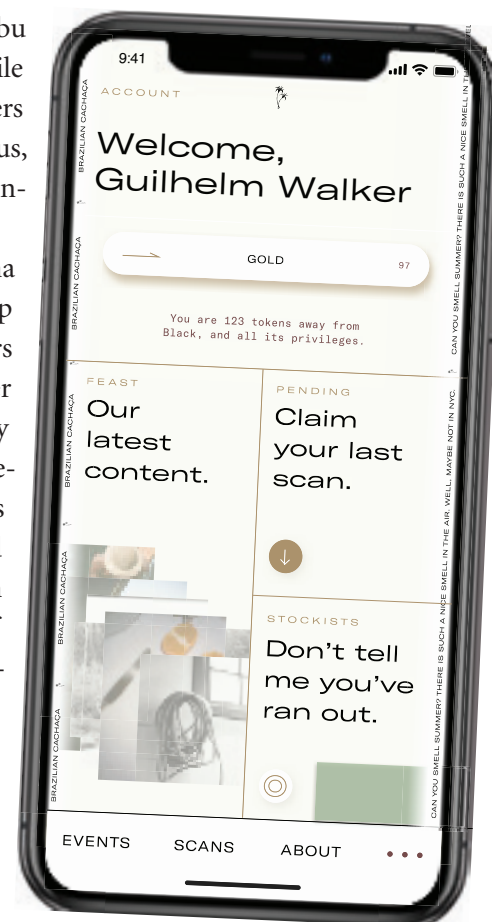



maverick
ENTERPRISES, INC
www.maverickcaps.com



#BeGreen

absolute green Line

IS AN EXCLUSIVE CAPSULE PRODUCED WITH **WATER-BASED INKS**
AND **POLYETHYLENE MADE OF 100% RENEWABLE RESOURCES.**

MAVERICK ENTERPRISES, INC. - 751 E Gobbi Street - Ukiah, CA 95482
email: marketing@maverickcaps.com - phone: 707-463-5591

Select Bottle Vendors

WINES&VINES BUYER'S GUIDE

This list of select vendors is generated using the Wines & Vines Buyer's Guide.

To see a full list of bottle vendors please visit: winesvinesanalytics.com/buyersguide

All American Containers, East Coast

Belle Vernon, PA ☎ 724-929-2070
www.allamericancontainers.com

All American Containers, a Veritiv Company

Windsor, CA ☎ 707-838-8864
www.aacwine.com

Ancor Rigid Packaging

Fairfield, CA ☎ 707-637-4205
www.amcor.com

Ardagh Group, Glass

Indianapolis, IN ☎ 707-200-9350
www.ardaghgroup.com



COUNTRY SOURCES: USA

WAREHOUSE LOCATIONS: CA, OR, WA, PA

MOLDS: Ardagh has a portfolio of more than 60 stock moulds to support the wine industry, which is accessible through our online catalog at www.ardaghgroup.com/wine2020

COLORS: Amber, Antique Green, Champagne Green, Dead Leaf Green, Green, Flint, Blue, Mist Green

Ball Corp.

Broomfield, CO ☎ 303-460-4444
www.ball.com

Berlin Packaging

Fairfield, CA ☎ 707-389-7600
www.berlinpackaging.com



WAREHOUSE LOCATIONS: Fairfield and Hayward, CA

MOLDS: unlimited

COLORS: Amber, Antique Green, Champagne Green, Dead Leaf Green, Green, Flint, Super Flint
FINISH: Champagne, Crown Cap, Flange, Regular Cork, ROPE, Screw Cap

OFFER: Bulk, Boxes

Beverage & Packaging Solutions

Panama City, Panama ☎ 507-308-5600
www.bps.com.pa

Bottles and More

Sacramento, CA ☎ 530-872-2745
www.bottlesandmore.com

Brewmaster

Pittsburg, CA ☎ 800-288-8922
www.brewmasterwholesale.com

Brick Packaging, A Saxco Division

Traverse City, MI ☎ 866-770-7600
www.brickpackaging.com

BSG HandCraft

Shakopee, MN ☎ 800-999-2440
www.bsghandcraft.com

Built in China

Temecula, CA ☎ 951-491-7500
www.builtinchina.com

CCL Container

Hermitage, PA ☎ 724-981-4420
www.cclcontainer.com

Ceramic Decorating Co

Los Angeles, CA ☎ 323-268-5135
www.ceramicdecoratingco.com

CFP Winemakers

Pittsburgh, PA ☎ 412-232-4507
www.cfpwinemakers.com

Dempsey International Packaging

Centennial, CO ☎ 720-405-9001
www.dempseyinternational.com

Encore Glass

Fairfield, CA ☎ 707-745-4444
www.encoreglass.com

EnVino Bottles

Burlingame, CA ☎ 650-259-5959
www.envino.com

Estal USA

Miami, FL ☎ 305-728-3272
www.estal.com/en

Exal USA

Youngstown, OH ☎ 330-744-2267
www.exal.com

Fortera

Tiburon, CA ☎ 415-890-2073
www.fortera.co

G3 Enterprises

Modesto, CA ☎ 800-321-8747
www.g3enterprises.com



Gallo Glass Co.

Modesto, CA ☎ 209-341-4527
www.galloglass.com



COUNTRY SOURCES: USA

WAREHOUSE LOCATIONS: Modesto and Lodi

MOLDS: 40

COLORS: Antique Green, Champagne Green, Dead Leaf Green, Flint, Eco Flint

FINISH: Crown Cap, Regular Cork, ROPE, Screw Cap, Bar Top

OFFER: Bulk, Boxes

Gepack USA

Peoria, AZ ☎ 602-737-9984
www.gepackusa.com

Gino Pinto, Inc.

Hammonton, NJ ☎ 609-561-8199
www.ginopinto.com

Global Package, LLC

Napa, CA ☎ 707-224-5670
www.globalpackage.net



Global Package

COUNTRY SOURCES: China, France, Germany, Italy, Mexico, Spain, USA

WAREHOUSE LOCATIONS: Napa, Portland, East Coast

MOLDS: 200

COLORS: Amber, Antique Green, Champagne Green, Dead Leaf Green, Green, Flint, Super Flint

FINISH: Champagne, Crown Cap, Flange, Regular Cork, ROPE, Screw Cap

OFFER: Bulk, Boxes

Glopak Wine and Spirits

Hicksville, NY ☎ 844-445-6725
www.glopakwineandspirits.com

Green Gen Technologies

Toulouse, ☎ +33 (0)5 31 98 89 92
www.greengentechnologies.com

Hauser Packaging, Inc.

Portland, ME ☎ 888-600-2611
www.hauserpack.com

Innovative Sourcing, Inc.

Yakima, WA ☎ 509-452-4800
www.innovativesourcing.com

IPS, Inc. (International Packaging Supply)

Fairfield, CA ☎ 707-425-9910
www.ipspkg.com

Kaufman Container

Cleveland, OH ☎ 800-824-4119
www.kaufmancontainer.com

Kefla-Glas GmbH & Co Kg

Bingen, ☎ +49 (0) 6721 96310
www.kefla.de

KinsBrae Packaging

Cambridge, ON ☎ 519-800-3521
www.kinsbraegroup.com

LD Carlson Co.
Kent, OH ☎ 330-678-7733
www.ldcarlson.com

Lodi Winery Laboratory
Lodi, CA ☎ 209-339-1990
www.lodiwinelabs.com

M.A. Silva USA

Santa Rosa, CA ☎ 707-636-2530
www.masilva.com



COUNTRY SOURCES: China, USA

WAREHOUSE LOCATIONS: Santa Rosa, Fairfield, CA; Kent, WA

MOLDS: 25

COLORS: Antique Green, Champagne Green, Dead Leaf Green, Flint

FINISH: Champagne, Crown Cap, Regular Cork, Screw Cap

OFFER: Bulk, Boxes

O-I
Perrysburg, OH ☎ 469-443-1000
www.o-i.com

Oak Tradition
Walla Walla, WA ☎ 509-200-9157
www.oaktradition.com

Pioneer Packaging
Kent, WA ☎ 253-872-9693
www.pioneerseattle.com

Premier Glass & Package Co.
Napa, CA ☎ 707-224-1660
www.premglass.com

Presque Isle Wine Cellars
North East, PA ☎ 814-725-1314
www.piwine.com

Quest
Stockton, CA ☎ 415-971-9624
www.byquest.com

Rich Xiberta USA
Cotati, CA ☎ 707-795-1800
www.xiberta.com

Richards Packaging
Woodland Hills, CA ☎ 916-399-0506
www.richardspackaging.com

Saverglass, Inc.

Napa, CA ☎ 707-259-2930
www.saverglass.com/en



COUNTRY SOURCES: France, Mexico, United Arab Emirates

WAREHOUSE LOCATIONS: CA, WA, KY

MOLDS: More than 3,000

COLORS: Amber, Antique Green, Champagne Green, Green, Super Flint, 8 Additional innovative colors (select colors), Customized Colors

FINISH: Champagne, Crown Cap, Flange, Regular Cork, ROPE, Screw Cap

OFFER: Bulk, Boxes

Saxco International

Concord, CA ☎ 800-328-6035
www.saxco.com



COUNTRY SOURCES: Global Sourcing

WAREHOUSE LOCATIONS: National Network

MOLDS: Widest Variety

COLORS: Amber, Antique Green, Champagne Green, Dead Leaf Green, Green, Flint, Super Flint

FINISH: Champagne, Crown Cap, Flange, Regular Cork, ROPE, Screw Cap

OFFER: Bulk, Boxes

Silver Spur Corp.
Cerritos, CA ☎ 562-921-6880
www.silverspurcorp.com

Somec Containers
Sanford, FL ☎ 773-844-7942
www.someccontainers.com/wine-cans

Spirited Packaging
Stockton, CA ☎ 209-462-6705
www.spiritedpackaging.com

TricorBraun
St. Louis, MO ☎ 314-569-3633
www.tricorbraun.com

TricorBraun WinePak
Fairfield, CA ☎ 707-399-5800
www.tricorbraunwinepak.com

United Bottles & Packaging

Sainte-Rose, QC, Canada
☎ 877-762-1867
www.unitedbottles.com

UNITED BOTTLES & PACKAGING

COUNTRY SOURCES: Chile, France, Germany, Italy, Spain, USA, Canada, Portugal, Belgium, Moldova, United Kingdom

WAREHOUSE LOCATIONS: Laval Quebec Canada, Vancouver British-Colombia Canada, Denver, CO USA, Austin, TX USA

MOLDS: Over 125

COLORS: Amber, Antique Green, Champagne Green, Dead Leaf Green, Green, Flint, Super Flint

FINISH: Champagne, Crown Cap, Regular Cork, Screw Cap, Swing-Top, Bar Top, Continuous Thread, Twist-Off

OFFER: Bulk, Boxes

Universal Packaging
Vernon, BC ☎ 866-549-1323
www.thinkuniversal.com

Verallia
Fairfield, CA ☎ 707-419-7200
www.us.verallia.com

Vetroelite
New York, NY ☎ 646-559-0674
www.vetroelite.com

The Vintner Vault
Paso Robles, CA ☎ 805-226-8100
www.thevintnervault.com

Waterloo Container Co.

Waterloo, NY ☎ 315-539-3922
www.waterloocontainer.com



COUNTRY SOURCES: China, France, Germany, Italy, Mexico, USA

WAREHOUSE LOCATIONS: 7 warehouses in Eastern US

MOLDS: 2422 Unique SKUs of Stock items, 20 beer molds, 97 liquor molds and 227 wine molds

COLORS: Amber, Antique Green, Champagne Green, Dead Leaf Green, Flint, Super Flint, Cobalt Blue, Mist Green, Georgia Green, Emerald Green

FINISH: Champagne, Crown Cap, Regular Cork, ROPE, Screw Cap, Combo Crown Cork, Swingtop, Continuous Thread

OFFER: Bulk, Boxes

West Coast Bottles, LLC
El Dorado Hills, CA ☎ 800-282-2028
www.westcoastbottles.com

Wine and Beer Supply LLC
Ashland, VA ☎ 844-482-9463
www.wineandbeersupply.com

World Wine Bottles & Packaging Solutions
Napa, CA ☎ 707-339-2102
www.worldwinebottles.com

Retail Sales Analysis

Wine Sales Flat as Cans Gain Ground

Wines Vines Analytics

Produced by Wines Vines Analytics, the *Wine Analytics Report* is the industry's leading source of market insights, objective analysis and data.

Sales Value Unchanged in January

Off-premise table wine sales were unchanged from a year ago in January. Table wine sales totaled \$1 billion in the four weeks ended Jan. 25, according to Nielsen scan data. The latest 52 weeks saw sales hold the course at \$14.4 billion.

Sales Volume Drops 3 Percent

Off-premise table wine volumes fell more than 3 percent versus a year ago, totaling 11.4 million 9 L cases in the four weeks ended Jan. 25. The decline represented an acceleration of movement in the latest 52 weeks, which saw volume drop more than 2 percent to 158.1 million 9 L cases.

Cans Lead Growth in Packaging Types

A mature market for wine may seem lackluster to producers, but the opportunities for growth now focus on consumption occasions. This means packaging wines for when and where consumers want to drink them. Just as corks gave ground to screw caps, now glass is giving way to boxes, cans and other packaging materials. Off-premise scan data collected by Nielsen indicate that canned wines are the most aggressive contender when it comes to glass bottle alternatives. Still, sparkling and other types of wines—from vermouth to wine-based cocktails—saw \$17 billion in sales in the 52 weeks ended Jan. 25. Glass held 89 percent of those products, with sales rising 1 percent, in keeping with the market as a whole.

Cans, however, logged 80 percent growth, with sales in the period totaling \$129 million. This represents less than 1 percent of the market but is still the fastest-growing packaging type. The second-fastest growing packaging type is the Tetra Pak wine carton, which grew 14 percent to \$253 million in sales, or more than 1 percent of the market. Boxes represent the second-most popular packaging type, containing nearly \$1.5 billion worth of wine, or 9 percent of the market. Sales increased more than 5 percent in the latest 52 weeks.

In terms of the value to consumers, boxed wines hold the cheapest product, with an average per-bottle price of \$3.47. While glass-packaging holds the most expensive wines, with a value of \$8.91 a bottle, cans are a close second at \$8.66 a bottle. Canned wines saw their average price increase 8 percent versus a year ago and 24 percent versus two years ago. The average price per bottle for all wine types was \$7.80 a bottle. **WBM**

Trended Off-Premise Value

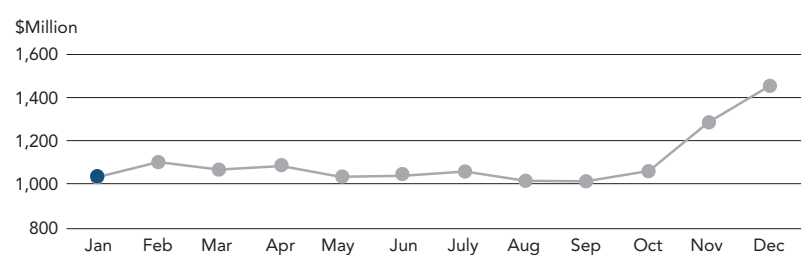

Trended Off-Premise Volume

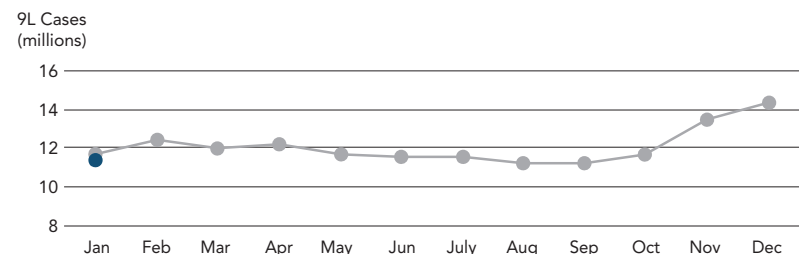

SOURCE: Nielsen. Latest 4 Wks - W/E 01/25/20

Average Bottle Price by Packaging Material

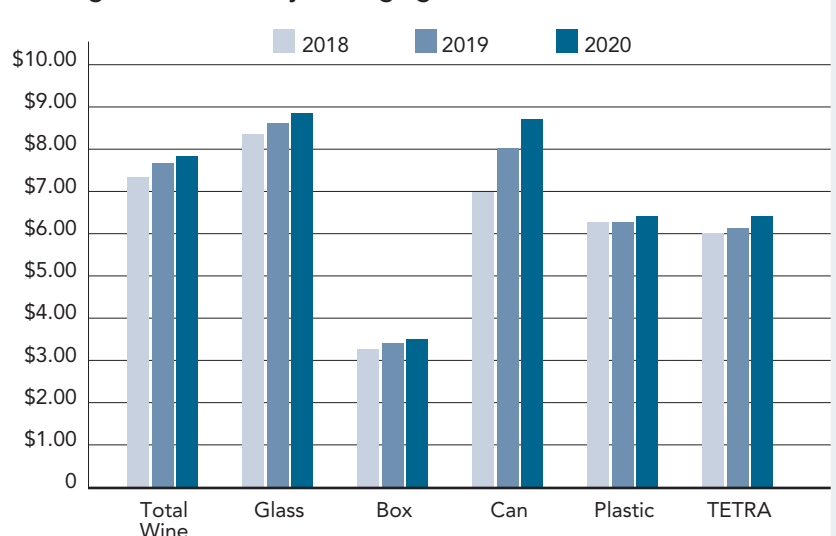

SOURCE: Nielsen, Latest 52 Wks - W/E 01/25/20 and comparable prior periods.

Methodology

Sourced from Nielsen, these figures represent off-premise retailer wine sales to the consumer aggregated across a variety of channels nationwide, including grocery, drug, mass merchandisers, convenience, dollar, military, as well as a selection of warehouse clubs, and liquor channel geographies and liquor channel retail chains. Nielsen figures are updated and released every four weeks.

Nielsen Table Wine Category Segments MARKET: Total US xAOC+Conv+Military+Liquor Plus PERIOD: Week Ending January 25, 2020

nielsen		Dollar Value				9L Equivalent Volume		9L Equivalent Volume % Chg YA		Avg Equivalent Price Per 750ML	
		Latest 52 Wks - W/E 01/25/20	Latest 4 Wks - W/E 01/25/20	Latest 52 Wks - W/E 01/25/20	Latest 4 Wks - W/E 01/25/20	Latest 52 Wks - W/E 01/25/20	Latest 4 Wks - W/E 01/25/20	Latest 52 Wks - W/E 01/25/20	Latest 4 Wks - W/E 01/25/20	Latest 52 Wks - W/E 01/25/20	Latest 4 Wks - W/E 01/25/20
TOTAL TABLE WINE		14,442,237,064	1,041,032,793	0.4	-0.3	158,103,331	11,429,001	-2.4	-3.2	7.61	7.59
PRICE TIERS BY CONTAINERS	BOX	1,431,390,141	108,518,571	5.1	3.3	33,990,936	2,547,532	1.3	-0.3	3.51	3.55
	\$0-\$3.99	575,394,262	43,500,121	-1.2	-1.3	19,773,628	1,475,466	-3.1	-3.9	2.43	2.46
	\$4+	855,906,162	64,979,890	9.9	6.6	14,215,720	1,071,333	8.1	5.1	5.02	5.06
	Total Table Wine Glass	12,728,806,373	912,978,378	-0.4	-0.9	120,779,312	8,652,168	-3.5	-4.1	8.78	8.79
	Value Glass \$0-\$3.99	632,053,093	46,263,612	-7.0	-8.3	15,632,133	1,141,915	-8.7	-9.1	3.37	3.38
	Popular Glass \$4-\$7.99	3,065,129,712	220,138,112	-5.8	-7.4	46,261,904	3,318,686	-6.7	-8.2	5.52	5.53
	Premium Glass \$8-\$10.99	3,256,067,156	230,729,816	-3.6	-5.3	28,636,608	2,010,255	-4.2	-5.7	9.47	9.56
	Super Premium Glass \$11-\$14.99	2,880,364,093	206,177,519	5.2	4.6	19,067,435	1,362,076	5.2	5.6	12.58	12.61
	Ultra Premium Glass \$15-\$19.99	1,448,428,792	104,095,095	6.5	6.5	7,102,233	508,534	7.0	7.9	16.99	17.05
	Luxury Glass \$20-\$24.99	600,790,809	42,202,370	6.2	11.0	2,295,282	160,301	5.7	11.5	21.80	21.93
Super Luxury Glass \$25+	796,319,247	58,269,889	2.8	6.3	1,645,772	120,353	1.5	6.4	40.31	40.33	
IMPORTED	IMPORTED	3,822,161,509	268,714,028	0.1	-0.2	39,418,152	2,818,581	-2.1	-2.9	8.08	7.94
	ITALY	1,215,552,103	89,496,006	1.5	2.5	10,411,904	752,715	-1.0	-0.9	9.73	9.91
	AUSTRALIA	714,907,377	54,032,863	-2.3	-3.6	11,678,859	886,626	-2.9	-4.2	5.10	5.08
	FRANCE	486,069,356	27,459,739	2.5	4.4	2,916,831	163,722	-2.8	0.2	13.88	13.97
	CHILE	253,197,970	18,461,904	-1.8	-3.9	3,830,474	281,292	-0.3	-3.4	5.51	5.47
	SPAIN	158,469,526	11,667,856	-5.8	-2.9	1,983,814	149,143	-5.2	-2.0	6.66	6.52
	GERMANY	75,287,696	5,224,710	-7.8	-4.1	710,800	48,818	-8.8	-6.6	8.83	8.92
	NEW ZEALAND	508,125,899	33,516,391	8.1	6.8	3,638,369	237,125	7.5	5.7	11.63	11.77
	ARGENTINA	320,857,089	23,253,848	-6.6	-9.7	3,475,671	251,630	-8.0	-11.1	7.69	7.70
	SOUTH AFRICA	22,629,281	1,440,167	-8.3	-11.0	191,386	12,157	-9.8	-13.4	9.85	9.87
	PORTUGAL	37,932,061	2,274,064	-9.7	-12.4	388,130	22,668	-15.5	-17.4	8.14	8.36
DOMESTIC	DOMESTIC	10,620,075,555	772,318,765	0.5	-0.4	118,685,179	8,610,420	-2.5	-3.2	7.46	7.47
	CALIFORNIA	9,561,740,172	698,059,975	0.5	-0.4	110,101,831	8,011,537	-2.5	-3.4	7.24	7.26
	WASHINGTON	607,677,647	42,516,680	-2.6	-1.7	5,028,529	349,738	-3.5	-1.5	10.07	10.13
	OREGON	220,310,362	15,772,927	12.0	10.7	1,121,204	78,924	12.0	11.1	16.37	16.65
	TEXAS	32,085,963	2,406,376	-1.1	-3.6	376,313	27,556	-5.2	-9.4	7.10	7.28
	NEW YORK	37,126,567	2,170,554	2.2	-0.7	472,613	30,966	-5.7	-6.0	6.55	5.84
	NORTH CAROLINA	40,513,632	2,941,588	0.1	-1.9	421,443	30,466	-0.3	-2.0	8.01	8.04
	INDIANA	23,137,836	1,723,402	-2.1	-7.7	253,719	18,661	-3.4	-8.7	7.60	7.69
	MICHIGAN	22,109,150	1,424,393	-0.9	-2.9	235,254	14,831	-3.3	-6.8	7.83	8.00
	TYPES	RED	7,424,835,129	559,976,064	-0.5	-1.3	72,231,930	5,418,451	-3.4	-4.4	8.56
WHITE		5,894,876,627	412,562,386	0.9	0.7	69,809,484	4,940,091	-1.4	-1.6	7.04	6.96
PINK		1,120,624,725	68,437,523	3.3	1.9	16,045,104	1,069,624	-2.3	-4.0	5.82	5.33
VARIETALS	TOTAL CHARDONNAY	2,547,107,420	179,455,357	0.0	-0.9	29,465,574	2,099,402	-2.4	-3.0	7.20	7.12
	TOTAL CABERNET SAUVIGNON	2,716,808,232	205,811,492	2.6	1.3	24,725,107	1,875,083	0.0	-1.6	9.16	9.15
	TOTAL PINOT GRIGIO/PINOT GRIS	1,347,418,575	94,188,283	3.1	3.2	17,384,832	1,232,451	1.9	2.2	6.46	6.37
	TOTAL PINOT NOIR	1,104,614,646	82,606,600	1.8	1.1	8,309,645	619,140	-1.8	-2.1	11.08	11.12
	TOTAL MERLOT	691,578,458	50,683,075	-7.5	-8.6	9,434,354	693,932	-9.7	-10.6	6.11	6.09
	TOTAL SAUV BLANC/FUME	1,003,792,463	68,175,290	6.5	6.6	8,754,539	598,660	5.4	5.7	9.55	9.49
	TOTAL MUSCAT/MOSCATO	629,769,934	47,567,787	-3.0	-3.9	9,461,601	705,719	-4.9	-5.8	5.55	5.62
	TOTAL WHITE ZINFANDEL	263,224,927	18,522,975	-8.3	-9.6	5,265,752	370,278	-9.7	-10.7	4.17	4.17
	TOTAL MALBEC	247,294,870	18,135,292	-6.9	-8.7	2,294,107	166,620	-8.2	-11.2	8.98	9.07
	TOTAL RIESLING	229,796,270	16,073,341	-6.8	-4.9	2,487,607	171,790	-9.2	-8.7	7.70	7.80
	TOTAL ZINFANDEL	220,229,323	16,428,235	-4.4	-5.0	1,542,582	114,052	-6.4	-7.4	11.89	12.00
	TOTAL SHIRAZ/SYRAH	142,119,103	11,073,128	-8.3	-3.7	1,585,620	125,082	-10.6	-4.5	7.47	7.38
	WHITE BLENDS (ex. 4/5L)	224,311,995	15,188,148	-2.5	-0.9	2,705,476	188,550	-2.8	-2.2	6.91	6.71
	RED BLENDS (ex. 4/5L + CHIANTI)	1,875,198,177	144,925,655	-0.1	0.4	16,907,970	1,299,486	-1.9	-1.6	9.24	9.29
	ROSE BLEND	576,830,020	28,975,985	13.5	17.1	4,870,945	264,975	11.5	13.5	9.87	9.11
GLASS SIZES	750ML	10,455,630,879	747,735,408	0.6	0.2	81,423,707	5,787,075	-2.0	-2.8	10.70	10.76
	1.5L	2,004,489,622	146,258,437	-4.8	-5.5	34,186,467	2,501,625	-5.9	-6.2	4.89	4.87
	3L	58,243,153	4,122,252	-9.0	-14.2	1,462,866	103,060	-13.3	-17.5	3.32	3.33
	4L	74,187,160	5,295,567	-8.7	-7.2	2,335,272	166,291	-10.5	-8.1	2.65	2.65
	187ML	102,247,667	7,058,743	-4.9	-5.4	1,222,262	83,118	-7.8	-8.3	6.97	7.08
	375ML	20,506,223	1,634,261	8.9	21.9	75,037	6,085	5.7	31.6	22.79	22.40
BOX SIZES	ex. 4/5L	951,036,746	72,549,451	9.0	6.3	16,785,834	1,273,694	7.1	4.5	4.72	4.75
	1L	30,965,746	2,267,303	6.7	-0.7	460,953	33,347	4.6	-2.4	5.60	5.67
	1.5L	26,992,147	2,053,297	1.4	2.1	530,198	40,869	0.7	2.7	4.24	4.19
	3L	678,815,733	51,518,536	8.1	4.7	13,030,656	988,173	7.2	4.0	4.34	4.34
	5L	480,350,703	35,968,904	-1.8	-2.3	17,205,030	1,273,833	-3.7	-4.7	2.33	2.35
	TETRA	245,714,579	19,013,094	12.6	11.7	3,229,892	245,016	7.8	7.2	6.34	6.47

Source: Nielsen

Growing with the DTC Universe

Fulfillment companies expand services for wineries in this booming sales channel

Jim Gordon

WINESHIPPING

Wineries increasingly look to fulfillment houses to facilitate their DTC businesses, and the number of providers has grown to accommodate that need.

WITH THE VALUE OF direct-to-consumer (DTC) wine shipments reaching \$3.2 billion and still growing by more than 7 percent, according to the latest Wines Vines Analytics/Sovos ShipCompliant Direct to Consumer Shipping Report, it's no surprise that shipping all that wine is a booming business, too. Dozens of companies have sprung up to provide warehousing and fulfillment services and hand off the boxes to FedEx, UPS and other carriers for delivery.

Few good metrics exist to measure the size of the DTC fulfillment and shipping business, but a glance at the volume of wine shipped and the square footage of the fulfillment facilities themselves shows that it is substantial.

"There has been an explosion in the number of companies doing the fulfillment," said Alex Koral, the senior regulatory counsel at Sovos ShipCompliant. "They have really established themselves as a vital partner in this industry. With all they offer in the way of storage and logistics, it takes a lot of headaches out of a winery's day to day existence."

Sovos ShipCompliant serves hundreds of wineries that do DTC shipments by ensuring they comply with the array of permits, taxes, fees and limits adopted by the 50 U.S. states. Sovos also partners with Wines Vines Analytics to calculate the industry standard data on DTC shipments.

The data encapsulated in the 2020 Direct to Consumer Wine Shipping Report show that the equivalent of 6.6 million 9-liter cases of wine were delivered in 2019. Since many, if not most, shipments contained less than 12 bottles, the number of packages shipped was likely much higher than 6.6 million.

The report noted that the sales value of DTC shipments grew by 7.4 percent in 2019, much higher than wine sales in general, but slower than the five-year average of 14 percent. It states that the average growth in volume for the past five years was 13 percent.

The authors wrote, "This predicted maturation of DTC shipping ushers in a new era of benchmarking for the channel—one that will now mirror traditional luxury goods over high-growth emerging channels."



Jim Gordon, editor at large for *Wine Business Monthly*, writes and edits articles on grape growing, winemaking and wine marketing. He has been covering wine and the wine business for more than 35 years, notably as the editor of *Wines & Vines* from 2006 through 2018. A role as contributing editor for *Wine Enthusiast* magazine began in 2014, in which he reviews California wines and reports on various California wine regions. He was executive director of the annual Symposium for Professional Wine Writers at Meadowood Napa Valley from 2008 to 2015. Dorling Kindersley (DK Books) of London published his first book as editor-in-chief, *Opus Vino*, in 2010, which was chosen as a finalist in the James Beard Awards. In 2002 he was co-creator and managing editor of the long-running *Wine Country Living* TV series for NBC station KNTV in San Jose/San Francisco.



**Deliver a great
experience —
7 days a week.***

FedEx®
Ground

FedEx Home Delivery® can help you reach customers faster than before. Now you can deliver to many residences on Sundays at no additional cost when you use FedEx Home Delivery.*

See how you can deliver seven days a week at [fedex.com/sundaydelivery](https://www.fedex.com/sundaydelivery).

Expertise Through Experience

Hoyt Shepston, Inc.

CUSTOMHOUSE BROKERS

Ocean & Air
International Freight
Forwarders

Serving your
import/export needs

161 Starlite St., Ste A
South San Francisco, CA 94080
wine@hoyt-shepston.com

650-952-6930

Fax 650-952-5691

How Large is the DTC Universe?

Another close observer of the DTC shipping business is international agribusiness lender Rabobank, whose 2020 Alcohol E-Commerce Playbook urges grocers and brick-and-mortar alcohol beverage retailers to build their own e-commerce capabilities quickly or face extinction due to competition from more digitally focused online retailers and marketplaces.

Based on data from multiple sources, Rabobank estimated that DTC wine sales of all types in 2019 totaled between \$5.5 billion and \$6.2 billion. This sum—not surprisingly—is much larger than the \$3.2 billion reported by Wines Vines Analytics/Sovos ShipCompliant because it includes wine that was not shipped, but purchased directly and carried out of winery tasting rooms and/or bought at events.

The Rabobank report's author, Bourcard Nesin, referenced an analysis by one of the leading fulfillment firms, WineDirect. The analysis covered more than \$1 billion in transactions from more than 1,000 U.S. wineries and found that wineries averaged 10 percent of sales through website sales and 37 percent through wine clubs.

After adding in one-time tasting room purchases that were shipped to the consumer's home or office, as well as telephone sales items that were shipped, it left 41 to 48 percent of direct sales that were not shipped, according to Rabobank.

That slice of DTC sales may not be where to look for the most potential growth, however. Nesin wrote, "For most smaller and mid-sized wineries, DTC sales are a critical source of revenue, but due to their size, most wineries have struggled to expand their e-commerce reach beyond consumers who have previously visited their tasting room. This will be the most important skillset moving forward."

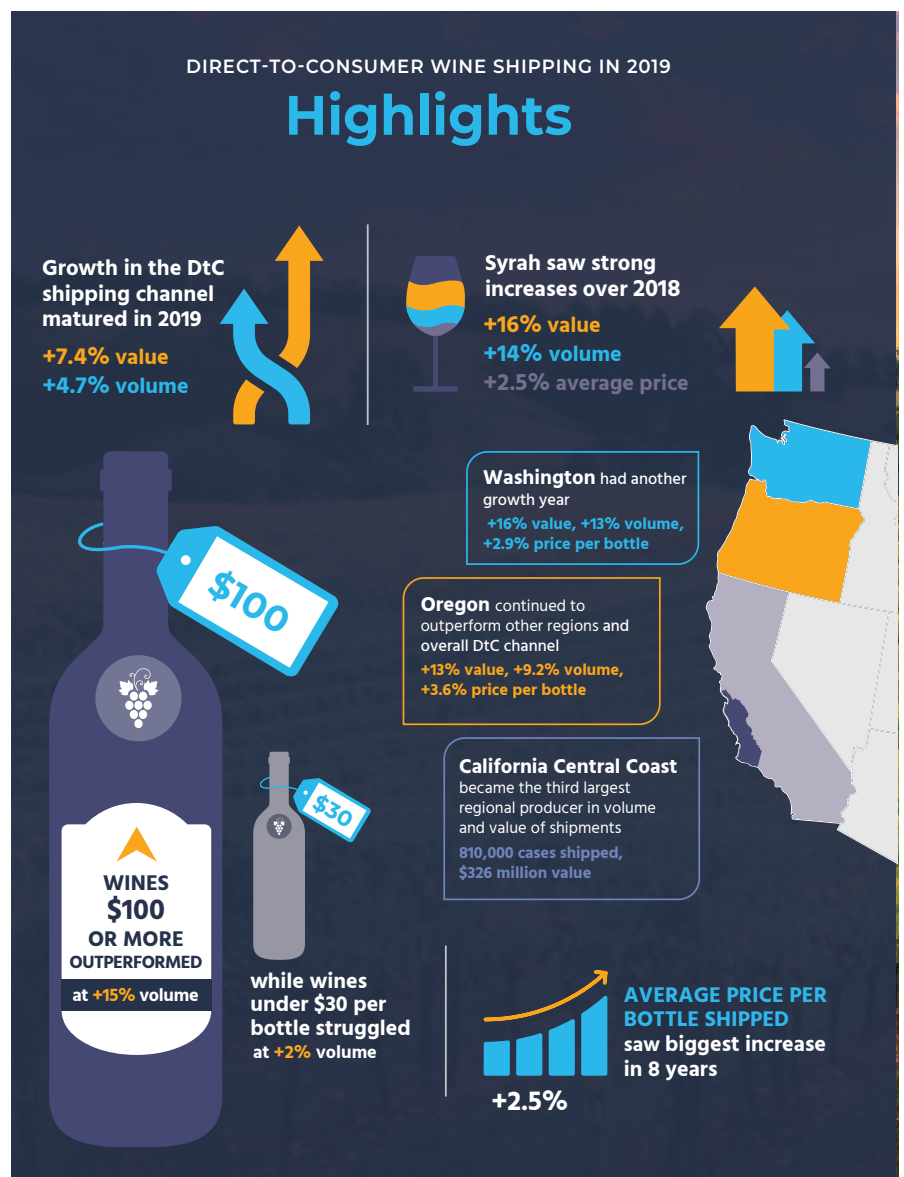

WINES VINES ANALYTICS/SOVOS SHIPCOMPLIANT



Offering a full range of professional design services including Master Planning

HALL & BARTLEY
ARCHITECTURE AND PLANNING

55 E STREET, SANTA ROSA, CA 95404 707-544-1642

www.hallandbartley.com

He continued, “Tasting room traffic, especially in premier wine-producing regions, is reaching maximum capacity, putting a damper on the number one driver of DTC sales. To make matters worse, wildfires are becoming a more frequent problem and can cause serious disruptions to tourism, even when they aren’t directly affecting wine country in California.”

Leading Fulfillment Firms

When asked what the top companies are, executives in the fulfillment business and close observers of the industry often name WineDirect and Wineshipping as the biggest in terms of number of orders fulfilled. This is followed by Vin-Go, LLC (incorporating Pack n’ Ship Direct) and several other companies that serve regional wineries.

What those companies, and dozens of smaller ones, do often starts with warehousing. Many warehouses offer temperature-controlled, licensed storage for case goods. The bigger companies will pick up pallets from wineries; some ask wineries to deliver to their storage facilities.

The bottles need to be in their possession for prompt packing and shipping in insulated and crush-proof boxes when the “dailies” (or one-time individual orders) come in, and to assemble and pack regular wine club orders—which can be much larger and serve wine club memberships as large as the tens of thousands.

How does a small but growing winery know when it needs a fulfillment partner? The CEO of Napa-based Wineshipping, Eric Lewis, said that small wineries often do their direct-shipping in-house, but can reach a point of diminishing returns. “When a winery approaches 2,000 cases shipped, they are on the threshold of being inefficient,” he said.

Wineshipping recently announced a joint venture with Vintners Logistics, LLC of Kennewick, Wash., that brings its total temperature-controlled wine storage to more than 600,000 square feet spread across six locations: Napa, Paso Robles and Santa Maria in California, plus centers in Oregon and Missouri.

Wine.com Built Its Own Shipping Model

A wine retailer that specializes in e-commerce had to invent its own model for direct-to-consumer shipping more than 20 years ago, and today dominates the national e-retailing wine business in terms of selection and reach.

Wine.com takes orders through e-commerce and does its own pack-and-ship operations at six locations around the country. They are technically retail operations, but, in effect, are simply warehouses with retail licenses so they can receive wine from wholesalers and deliver it to consumers within their state or region, as allowed by law, via FedEx.

Wine.com maintains that it’s the leading U.S. online wine retailer by revenue, traffic, selection and geographic reach. In January, the firm reported \$150 million in 2019 revenue, up \$20 million from the previous year.

CEO Rich Bergsund has been with the company since 2006. He called their model “3TE,” for three-tier e-commerce. “There’s still a discussion in the wholesale world about whether e-commerce companies are cutting them out, but in our case we’re not,” he said. *Wine.com* partnered with 100 wholesalers and 5,000 wineries to offer 45,000 SKUs in 2019.

Few pure-play online retailers are in the same space, Bergsund said. *NakedWines.com* and *Winc, Inc.*, as well as a number of flash-sale websites, are similar in that they lack public brick-and-mortar stores, but they don’t offer as broad a selection as *Wine.com*, which is made up of more than 50 percent imported wines.

the business side of wine



increase your
direct-to-consumer
sales

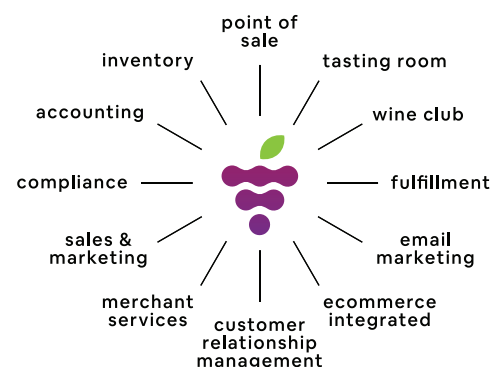

Your passion is making wine. Ours is helping you sell it.

microworks technologies, inc., napa california
winesoftware.com | info@winesoftware.com | 707.224.9620

Creative solutions to inspire.

Sommelier enhances the overall bottle silhouette and aesthetic, at the same time offering real functional benefits. Through its unique neck design, Sommelier incorporates a unique groove allowing for clean cut and easy removal of the capsule whilst also acting as an anti-drip ring.



Global Package

CALIFORNIA, NORTHWEST & EAST COAST

info@globalpackage.net

707 224-5670

globalpackage.net

IS YOUR PEST MANAGEMENT PROGRAM AUDIT READY?



REMEMBER ONE

ONE FOCUS

Since 1937, IFC has provided a full range of products and services exclusively to the food and commodity industries. This expertise gives us a distinct advantage and understanding of every type of food handling environment.

ONE LESS THING TO WORRY ABOUT

Save time and money. Eliminate stress. Know that your pest management program remains in compliance with detailed reporting and the best care possible.

ONE SOURCE

We offer a comprehensive list of products and services so there is no need to look beyond IFC.

ONE OF A KIND

IFC is the only nationwide pest management firm exclusively focused on the food industry.

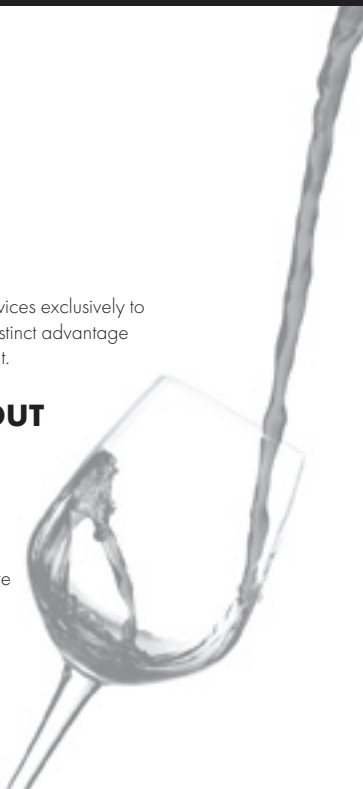

CONTACT US FOR A COMPLIMENTARY
IPM FACILITY ASSESSMENT

1-800-477-4432 • www.indfumco.com

Growing with the DTC Universe



WINEDIRECT

With five warehousing and distribution centers, WineDirect offers nearly 600,000 square feet of storage space.

Lewis said Wineshipping's footprint and scale mean it can promise two-day delivery to about 95 percent of U.S. consumers and one-day delivery in several metro areas. A majority of Wineshipping's winery customers produce 3,000 to 50,000 cases a year, and "a few" produce 1 million cases or more, he said.

Wineshipping is now stressing services for its winery customers beyond just warehousing and fulfillment. It is promoting its consulting and digital marketing services and can help with DTC strategy, calling on a newly hired business analyst and market analyst, among other resources.

The Cost of Fulfillment

The other big Napa-based fulfillment company, WineDirect, touts its services as being "end to end," including not just pick-up, packing and shipping, but everything from winery point-of-sale software to e-commerce solutions, and even what they call marketplace solutions that connect wineries to third-party platforms, such as eBay and Vivino.

WineDirect's fulfillment business is at its core, however. Fulfillment revenue has doubled three times in the past seven years, according to VP of marketing Jim Agger, and the company expects to ship more than 2 million packages in 2020. "Our customers' shipments have been growing slightly faster than the DTC Shipping Report, partly because of our fulfillment services, but also our customer base chooses us because we have services that are totally committed to DTC," Agger said.

The company's fulfillment centers are in Napa Valley (American Canyon), California's Central Coast (Paso Robles and Santa Maria), the Willamette Valley and in northern Ohio, where a staging center holds inventory from across the country for quicker shipping to consumers in Midwestern and Eastern states. WineDirect's five centers total nearly 600,000 square feet in size.

Agger ball-parked the cost of fulfillment by WineDirect and shipping by FedEx or UPS as ranging from about \$5 per bottle when shipped as a whole case of 12 bottles, to \$9 a bottle for a typical wine club shipment of



KILR-CHILR

Temperature Controlled Tank

Fully Insulated, Updated Controls
Turn Key, No Glycol



Tanks

225 to 4500 Gallons



30 years producing polyethylene tanks for wine and cider



208-549-1861

winetanks@pascopoly.com

www.pascopoly.com

four bottles. He said the biggest challenge in pricing has been annual rate increases by the carriers. *Logistics.com* estimated that total to be 76 percent from 2010 through 2020.

These rising costs are particularly worrisome in light of WineDirect's own research that showed high shipping costs are a big factor in discouraging sales by their customers. It means lower margins for many wineries, according to marketing director Adrienne Stillman. "We see a strong correlation between lower shipping fees charged to consumers and their sales. It's hard for small businesses to look at that margin and kiss it goodbye, but you're losing sales and losing goodwill with your customers if you don't," she added.

"Think of the effect on people ordering online who get to the checkout and see the shipping fee is \$25 or \$35. These consumers are getting trampolines and swing sets delivered to their homes with free shipping," she said.

Inside the fulfillment centers, the growth of daily orders and customized wine club shipments has prompted WineDirect's adoption of new picking and packing equipment, including a "pick to light" technology that visually guides workers to select the right bottles to include in a box.



WINESHIPPING

Wineshipping's footprint and scale mean it can promise two-day delivery to about 95 percent of U.S. consumers and one-day delivery in several metro areas.

Turn-key Solutions

The addition of e-commerce services to a DTC fulfillment house's role appears to be a growing trend, with Wineshipping now emphasizing them, too. Analyst Bourcard Nesin at Rabobank says it's a timely response to the increasing importance of DTC sales. "My research has shown that the opportunity is much larger than previously thought," he said. "This means that there is ample opportunity for sales to continue moving to digital channels, and for wineries to take advantage of the data and scale provided by large service providers that offer turn-key solutions.

"I also think that some mid- to large-sized wineries may see the market opportunity and decide that the DTC market is large enough to risk a more rocky relationship with distributors," Nesin said. "That, in turn, could lead to more growth, innovation and investment in the DTC wine space." **WBM**

Yomp Box
inflatable protective packaging

- ✓ DIM Weight Reduced up to 30%
- ✓ Low-Profile, Flexible, & Super-Strong
- ✓ Reduce Warehouse Space up to 90%
- ✓ Semi & Fully Automatic Inflation Equipment
- ✓ Cold Chain, Temperature Controlled Solutions

REUSABLE → RECYCLABLE → BIODEGRADABLE

We are your e-commerce "box-less" shipping solution!

San Jose, CA | (408)394-4966 | info@yompbox.com

Visit us online at YompBox.com

Serving the
Wine Industry
Since 2002

ROSECITY
TRANSPORTATION, INC.
AN FMCSA LICENSED BROKER

800.826.0438
201 NE Second Avenue, Suite 201, Portland, Oregon 97232
em) info@rosecitytransinc.com
www.RoseCityTransInc.com

25 YEARS

Private Equity Still a Niche Player in Wine

Kerana Todorov

Kerana Todorov is staff writer/news editor with *Wine Business Monthly*. She can be reached at ktodorov@winebusiness.com.

TRADITIONAL, STRATEGIC INVESTORS, like E. & J. Gallo Winery, Jackson Family Wines and The Wine Group are active in the United States' winery and vineyard mergers and acquisitions market, as are international wine players, such as Pernod Ricard and Concha y Toro. But a third group of investors in the wine space, private equity firms, are making efforts to build wine portfolios—if the investment is right.

In 2015, J.W. Childs Associates (now Prospect Hill Growth Partners) became the majority owner of Kosta Browne. In 2016, TSG Consumer Partners acquired Duckhorn Wine Co. from GI Partners, another private equity firm. Two years later, in 2018, The Carlyle Group bought Australia-based Accolade Wines from CPE Capital. In March, Third Leaf Wines, a division of Third Leaf Partners, added Waters Winery and 21 Grams of Walla Walla, Wash., to its portfolio.

These private equity firms are among those that remain active in the wine space today.

The Private Equity and Wine Relationship

Private equity has played a part in the wine industry for several decades. In 1985, New York-based Ardshiel Inc. invested in Golden State Vintners, a company started by the grandfather of Jeff O'Neill, founder of O'Neill Vintners and Distillers. Under the private equity firm, Golden State Vintners grew and eventually went public in 1998.

"That's how I started," said O'Neill, who founded O'Neill Vintners and Distillers in 2004. "Private equity allowed me to really get into the business."

Adam Beak, managing director of the beverage group at Bank of the West, noted that most of these private equity firms either have historical experience in the wine industry or their members have exposure to the wine space. It's a hard industry to "parachute into" to do just one deal, Beak said. "It's a fairly niche market for private equity," he said.

"A private equity buyer has a finite time interest in ownership. Said another way, the goal of a private equity fund/buyer is to 'buy low and sell high.' The fund's primary objective is to deliver an above-average return to its investors—within the duration/life of the fund."

George Hamel Jr., Hamel Family Wines

Accordingly, the number of private equity groups in the wine space is small for a variety of reasons. The industry is very asset-intensive and has a very long operating business cycle; wineries maintain two to four years' worth of wine inventory. Beak also noted that there are federal tied-house rules in place to follow. Funds that invest in the winery side of a business cannot also invest in its retail business, for example.

Vintner George Hamel Jr., co-owner of Hamel Family Wines, whose first career was in finance, said private equity investors are different from a strategic buyer, such as a winery. "A private equity buyer has a finite time interest in ownership," Hamel said. "Said another way, the goal of a private equity fund/buyer is to 'buy low and sell high.' The fund's primary objective is to deliver an above-average return to its investors—within the duration/life of the fund," Hamel said.

Beak estimated a fund's cycle usually lasts a decade. "But that's hard within our environment," he said, and added that it's often difficult to obtain the kind of growth a fund would expect within three to six years. "Often times, it takes longer than that."

Mario Zepponi, founder and principal of Zepponi & Co. in Santa Rosa, Calif., said private equity firms that jump into the wine space usually have consumer product experience. "We welcome them because it provides additional buyers, additional balance in the marketplace," he said during a presentation last summer. The typical hold period for a private equity's investment is 5 to 7 years.



The ideal complement to your winery.

EMC provides businesses the right coverage at the right price — and has for more than 100 years. We offer a full range of product options to properly insure your operation, including coverages like equipment breakdown, beverage contamination, in-transit damage, and employee and guest injuries.

For the perfect blend of protection and service, visit:

www.emcins.com/wine



www.emcins.com

©Copyright Employers Mutual Casualty Company 2020.
All rights reserved.

count on
EMC
INSURANCE

NOW AVAILABLE

WINES & VINES DIRECTORY/BUYER'S GUIDE

Order the 2020 Wines & Vines Directory/Buyer's Guide for only \$95.* Get the most current and comprehensive print and online guide to wine and grape industry professionals, products and services in North America.

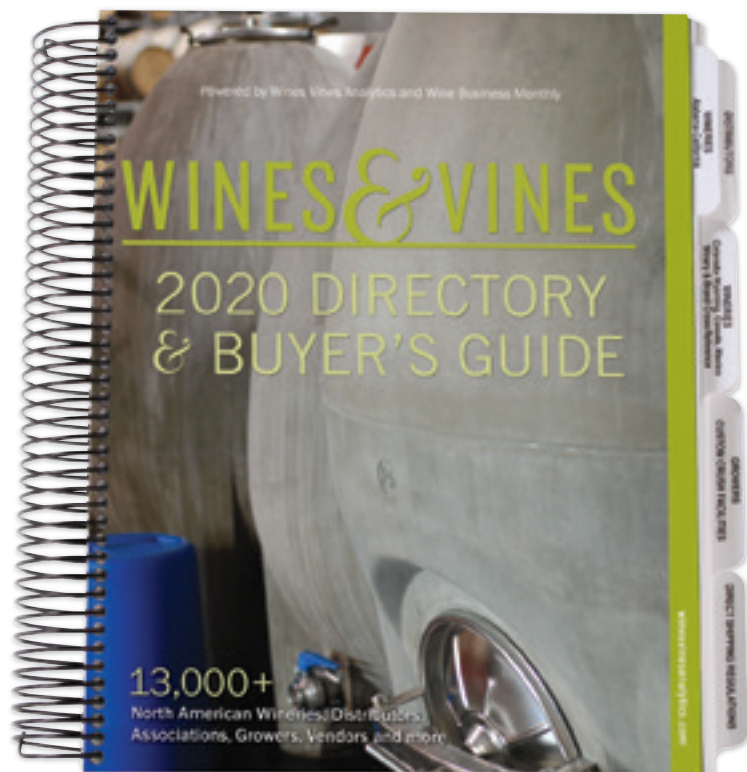

*\$95 rate includes shipping within the U.S. only. Rates for other countries apply.

FREE SHIPPING*

ORDER TODAY!
winesvinesanalytics.com/order

Will There Be More Investment?

According to wine industry professionals interviewed for this story, more transactions involving private equity firms are expected.

"I wouldn't be surprised to see more," said Luc Arsenault, partner at Moss Adams, a professional services firm.

Despite headwinds, including the national dip in wine consumption and ongoing trade issues, Beak said that the market remains healthy. "(Private equity firms) are being more careful than they were a year ago, two years or three years ago. However, they're still looking," Beak said. "They're still willing to do the right type of deals."

The right type of deal for these investment firms, according to Rob McMillan, executive vice president and founder at Silicon Valley Bank, includes more vineyards than wineries.

"The market for winery acquisitions is a little cool right now, but there are some who are trying to pull together vulture funds to perhaps take advantage of any weaker players exiting the business over the next decade," McMillan said. In the past, private equity funds looking to buy a winery on the cheap ended up being disappointed, McMillan noted.

Hamel has noticed a general increase in the number of transactions in the wine business overall.

"When you look at an increase in transactions in any industry, there are often industry-specific reasons as well as generally favorable macro reasons. In the wine industry, it is likely a combination of both macro and micro factors," Hamel said. "From a macro perspective, interest rates have remained low for buyers using debt, and stock values have remained high for those public acquisition-minded companies who may use their stock as acquisition 'currency.' That has contributed to both a transaction-friendly environment as well as a favorable fund-raising environment for private equity."

Micro reasons might include a combination of factors, including the fact that many wineries begin as family-run businesses. "Often, there may be no next generation or next-generation interest in running the business, so the owners/founders may seek a transaction to monetize what they have built once they want to retire or step back," Hamel added.

Sellers may perceive future headwinds and, from a valuation perspective, will want to sell near the top of the cycle. "It seems to me that we may be closer to a cyclical top in a cycle and, hence, a more favorable environment to monetize an investment—if one is likely to be a seller at some point in the intermediate-term anyway," Hamel said.

One of the more recent investment headlines came when WarRoom Ventures LLC of Santa Margarita in San Luis Obispo acquired Bonny Doon Vineyard earlier this year. WarRoom Ventures, which also owns Lapis Luna, does not consider itself to be a traditional private equity firm.

"WarRoom is not structured as a traditional private equity company with a finite entry and exit period," said WarRoom Ventures president Andrew Nelson. "We are, however, aligned with different capital sources who have deep experience in agriculture and branded products with a long term vision. We're more of an operating wine company with access to capital."

Nelson said his company views the wine industry as "attractive."

"We believe there are great opportunities to pair smart, long term capital with experienced industry managers and brands that resonate with consumers and have the ability to grow," Nelson said. "The acquisition of Bonny Doon and Lapis Luna are consistent with that thinking."

In the meantime, deals that are on the fence involving private equity firms are less likely to happen today than they did one or two years ago, as companies may wait on the sidelines waiting to buy assets for less, Beak said. Still, iconic assets like a Duckhorn or a Far Niente defy gravity and continue to trade. **WBM**



CONGRATULATIONS TO THE 2020 WINNERS!

CALIFORNIA GREEN MEDAL

SUSTAINABLE WINEGROWING LEADERSHIP AWARDS

Recognizing California Vineyards and Wineries that Excel in Sustainability with Four Awards:



LEADER

J. Lohr
Vineyards
& Wines



ENVIRONMENT

Bonterra
Organic
Vineyards



COMMUNITY

Clif
Family
Winery



BUSINESS

Pisoni
Family
Vineyards

To learn more about 2020 Green Medal winners, visit www.greenmedal.org

EXCLUSIVE MEDIA SPONSOR

WINE BUSINESS MONTHLY

SILVER SPONSORS

MCE

Grow West

Farm Credit Alliance

PRESENTED BY:



For sponsorship opportunities, visit www.greenmedal.org or contact info@greenmedal.org.

Winemaking & Wineries

HALL Family Wines promoted Megan Gunderson to director of winemaking. In her new role, Gunderson is now responsible for the production and direction of all wines produced under the HALL, WALT and BACA brands. Gunderson has been a member of the HALL winemaking team since 2005 and head winemaker for WALT Wines since 2010.

Jordan Vineyard & Winery added three new leaders in administration, winemaking and viticulture: Devonna Smith, Maggie Kruse and Dana Grande. Devonna Smith joins Jordan Winery as chief financial officer, succeeding Ron Kampel, who has worked at Jordan for 24 years and has led the company's accounting, human resources and information technology departments since 2005. Smith has served as CFO and chief of staff at Chappellet Winery and Vineyard since 2013. Maggie Kruse, who was promoted to winemaker at Jordan last summer, will now oversee both winemaking and winegrowing at Jordan. Kruse joined Jordan in 2006 as enologist and was mentored by longtime Jordan winemaker and winegrower Rob Davis, who retired in 2019. Dana Grande has returned to Jordan in the newly created role of grower relations manager, reporting to Kruse. Grande worked in the Jordan Estate vineyards from 1999 to 2012, before moving to Ferrari-Carano Winery as its grower relations manager.

Oak Farm Vineyards announced that Sierra Zeiter is its new head winemaker, taking over the role from Dan Panella, who is now director of winemaking. Most recently, Zeiter worked as the assistant winemaker at Oak Farm Vineyards, where she managed and organized production on a day-to-day basis in collaboration with the rest of the Oak Farm winemaking team. She has a Bachelor of Science degree in wine and viticulture with a concentration in enology from California Polytechnic State University, San Luis Obispo.

Bogle Vineyards and Winery hired Paul Englert for the newly created role of vice president of marketing. In this position, Englert leads brand and marketing strategy for Bogle's three wine brands, Bogle, Phantom and Juggernaut, as well as direct-national programming, lead innovation and streamline-messaging across all platforms.

Quilceda Creek appointed Scott Lloyd as the winery's general manager. In this role, Lloyd oversees winery operations, consumer-facing channels and marketing efforts. Lloyd has worked in the wine business for nearly two decades with a focus on developing luxury brands for family-owned boutique wineries in the Napa Valley.



Megan Gunderson

DeLille Cellars announced that their former enologist, Mari Rossi, has been promoted to assistant winemaker, under the direction of director of winemaking and viticulture, Jason Gorski. Rossi started at DeLille in 2014 after receiving a degree in viticulture and enology from Cornell University and working harvests in Sonoma, Napa and New Zealand. DeLille Cellars also promoted Nick Bernstein, former assistant winemaker, to winemaker. He will continue to work closely with Gorski as well. Prior to joining DeLille in 2012, Bernstein received a B.S. in biology from the University of Washington and worked harvests in Walla Walla, Sonoma and New Zealand.



Mari Rossi and Nick Bernstein

Brecon Estate hired Ryan Pease as its new winemaker, working alongside founding winemaker Damian Grindley. Pease began his career with a part time tasting room position at Linne Calado. His first harvest was working alongside Matt Trevisan in 2007 as a vineyard and cellar hand, then moved on to work with Epoch Estate for the next two harvests. In 2010, he returned to Linne Calado as assistant winemaker for the 2010 and 2011 harvests. Pease also has his own wine label, Paix Sur Terre.

Archer Roose Collective introduced two new executive-level members to its sales leadership team, Bill Dillon and Aaron Moore. Dillon is now the vice president of sales and marketing; Moore is now the national accounts director. Both bring aboard extensive beverage industry experience. Their responsibilities include increasing exposure of the Archer Roose portfolio to new market segments, such as canned alcohol and low-ABV beverages, and assisting with the company's expanding distribution across the U.S.



Paul Englert



Bill Dillon

Aaron Moore

Tenzing Wine & Spirits appointed Patrick Witt as the company's new general manager and vice president of sales. Witt is now responsible for leading and executing all sales and trade development initiatives while maintaining the company's commitment to excellence in brands and services and superior supplier, customer and partner relationships.



Patrick Witt

Nicolas-Jay appointed Kevin Schlachter as national sales director. Schlachter leads Nicolas-Jay's national sales efforts in existing markets and expansion into new territory. Previous to his employment at Nicolas-Jay, Schlachter worked several other sales positions within the wine industry, including Kobrand Corporation, Wine Group LLC and Young's Market Company. He is a Certified Specialist of Wine by the Society of Wine Educators and a Certified Sommelier by the Court of Master Sommeliers.

Rocky Pond Estate Winery named John Ware as its new president. Ware has spent the past 20 years at Quilceda Creek Winery where he served in several positions, including the cellar, administration, national and international sales and, finally, as general manager.

Santiago Cilley, CEO of Phantom Creek Estates, announced the winery's collaboration with vintner Philippe Melka. Melka now serves as the consulting winemaker for Phantom Creek's red wine program, working closely with winemaker Francis Hutt.

Matt Freeman was hired as the director of sales for Torii Mor Winery in Dundee, Ore. His primary responsibilities include sales and distributor management. Freeman is an experienced sales manager who has handled marketing budgets and sales programs in numerous positions.

WX Brands announced that Jeff Ngo has joined the company's executive team as senior vice president of marketing. Ngo now leads the company's marketing and direct-to-consumer efforts for its growing portfolio of nationally distributed wine brands, as well as its exclusive brands. Ngo joins WX Brands with more than 20 years of experience and with a specialty in brand management at multi-brand portfolio companies, including Jackson Family Wines, E. & J. Gallo Winery and Diamond Foods.



Jeff Ngo

Alpha Omega Collective (AOC) and Perinet named Nina Leschinsky as the United States brand manager for Perinet. Perinet is the AOC's Spanish winery located in the Priorat region. Leschinsky will liaise with the U.S. sales teams, including the AOC wholesale team, the Alpha Omega Collective tasting room in downtown Napa, the Tolosa tasting room team and the AOC offsites division, as well as coordinate with the team in Spain. She will run the Perinet U.S. wine club, managing direct-to-consumer campaigns, and develop overall strategy to enhance the brand's continued growth.

St. Supéry Estate Vineyards hired for two key sales positions: Tami Richards is now vice president, national sales manager; Elizabeth Parenteau is now southeast regional manager. Richards replaces Susie Owen who retired after nine years with St. Supéry Vineyards & Winery. Parenteau replaces Jackie Campbell who is also retiring. Each woman comes to her new role with experience in both sales and leadership positions within the wine industry.

Opus One Winery appointed Mike Delonis as chief financial officer. Delonis is now responsible for developing and maintaining analytical frameworks to support the organization's strategic planning, overseeing the development of financial planning, budgeting and modeling systems and directing the coordination of the accounting, human resources and information technology departments.

After four years of study, Black Hills Estate Winery winemaker, Ross Wise, is Canada's newest Master of Wine. Only 396 people worldwide have achieved the status since the first exams began in 1953, with only 60 in total across North America. Wise is the seventh to be awarded the honor in Canada and the fourth in British Columbia.

Distributors, Importers & Retailers

Cassidy Browne has been promoted to sales manager at Left Bank Wine + Spirits after working as one of their Milwaukee sales representatives for six years. Browne oversees a staff of 22 sales representatives, based throughout the state of Wisconsin.



Cassidy Browne

Quintessential Wines hired Dewey McBride for the newly created role of director of California retail chains. In this position, McBride works with the management of all key retail chains based in California, to secure and maintain placements of Quintessential's portfolio. Quintessential Wines has also three new sales team members. Carmen Waggoner was hired as the company's new regional sales manager for Arizona, New Mexico, Nevada and Hawaii. Tina Holden, who previously handled North Bay area sales for Quintessential, is now leading the Northern California sales team. Holden oversees all Northern California sales programming. Lastly, Peggy Davis, is now taking over Holden's former role, working with all levels of the distribution chain in the North Bay, including off- and on-premise trade and sell-through to consumers.

House of Saka, Inc., hired Sue Bachorski as its new chief operating officer. Bachorski oversees operations, logistics and finance for the company as it continues to expand its portfolio of products as well as its national footprint.



Sue Bachorski

Industry Services & Suppliers

Cork Supply promoted Greg Hirson to vice president of product, CSU. In this new role, Hirson focuses on portfolio strategy, continues to supervise the direction of laboratory operations at the company's facility in Benicia, Calif., as well as direct quality control measurements for all products and services of Cork Supply USA and Tonnellerie O—the company's oak cooperage. Hirson also manages Cork Supply's SIOF process, ISO, Food Safety Certification and cost management for all cork products. He reports directly to Peter Hladun, vice president and general manager, CSU.



Greg Hirson

Marilyn Vogel, a wine industry professional with more than three decades of experience in wine-brand building, has created Vintners Collections & Consulting LLC. The company represents wine producers who prefer to outsource their sales and marketing efforts. The goal is to help these producers find ideal product placement in the current, highly competitive market.

Ekos appointed Christina Kyriazi to vice president of marketing and Chris Smith to vice president of engineering. In her new role, Kyriazi assists with the company's growth and expansion into new markets. She reports to Ekos CEO Josh McKinney. Smith was brought on to help the company scale its engineering team, process and software. He reports to Ekos CTO, and co-founder, Greg Forehand.

Dimensional Insight hired John Kievit as vice president of goods and services, industry strategy, and business development. Kievit brings nearly 40 years of experience to the role, including work as an administrative vice president for both sales and marketing. As part of his new role, Kievit creates and aligns products and services to aid in customers' success.

Gary's Wine and Marketplace appointed Chris Poulos as its new beverage purchasing and sales manager of the new St. Helena store, which opened fall 2019. Poulos has more than 20 years of wine industry experience, including at North Berkeley Imports, Vinum Importing & Distributing, Oregon's Soter Vineyards, and Napa's Bounty Hunter Rare Wine & Spirits and Company Fine Wine.



Chris Poulos

Vinfolio appointed Adam Lapierre, MW as the company's new president. Lapierre has been with Vinfolio for two years. Lapierre has a background in various industry roles, including as a supplier and a buyer. Lapierre also serves on the Education Committee for the Institute of Masters of Wine and regularly judges at wine competitions around the world.

Pat DeLong, founder of Napa Valley-based Azur Associates beverage advisory firm, announced the addition of international winemaker Matt Parish to his group. Parish has worked in senior winemaking and production roles at several large wine companies, including Constellation Brands, Treasury Wine Estates and *Nakedwines.com*.

Terrafina Restaurant at Hester Creek Estate Winery reopened for the season on March 4, under the new direct management of Hester Creek. The restaurant is now led by executive chef Adair Scott and restaurant manager, Paul Henbury. Scott joins Hester Creek from Watermark Beach Resort in Osoyoos, where, as their executive chef for the past seven years he received numerous honors for his innovative approach to fresh, healthy, local cooking. Henbury has over two decades in hospitality. He got his start in a culinary career working at Montreal's grand hotel, Fairmont Le Reine Elizabeth.

I found my job at
winejobs
.com

Associations & Education

Barbara Banke, chairman and proprietor of Jackson Family Wines, is the 2020 recipient of The Wine & Spirits Wholesalers of America (WSWA) Sidney Frank Innovation Award. The award honors individuals in the industry who have advanced their companies overall success and profile, contributed to their communities and represent a new, higher standard for the industry. Under Banke's leadership, Jackson Family Wines continues to support more than 200 nonprofit organizations in the regions where their employees live and work. The company also supports multiple regional wine auctions across the U.S. that give back to vital local nonprofits organizations and charitable causes. Banke will be recognized at WSWA 77th Annual Convention & Exposition to be held at Caesars Palace Las Vegas, April 20-23, 2020.



Barbara Banke

Professor, author and sensory scientist Dr. Hildegard Heymann is being recognized as the 2020 recipient of the American Society for Enology and Viticulture's (ASEV) highest honor, the ASEV Merit Award. She will be honored this June at the Joint 71st ASEV National Conference and 45th ASEV Eastern Section Annual Meeting in Portland, Ore., where attendees will have the opportunity to hear her Merit Award presentation, "Forty Years of Wine and Sensory Science."



Michelle Moyer

Associate professor and extension specialist Dr. Michelle Moyer, will receive ASEV's Extension Distinction Award. She will be honored at the joint 71st ASEV National Conference and 45th ASEV Eastern Section Annual Meeting in Portland this June, where she will give a presentation entitled "Land Grants and Grapes: Traditional Approaches for Modern Extension Programs."

Women for WineSense Napa-Sonoma, the founding chapter for the national organization, named consulting DTC director and hospitality specialist, Amanda Carder, as the incoming president. She is taking over for Maryam Ahmed, public programs director for The Culinary Institute of America, who will continue to support the board in an advisory role. Carder has worked for several wine brands on the hospitality and DTC side of the business. She previously served on the board of the Napa Valley Hospitality Forum as their innovations director and was also a board member of the Wine Country Wine Chicks.

Obituaries

Long recognized as one of the founding fathers of the modern El Dorado County wine region, Richard Harding (Dick) Bush, born April 4, 1934, passed away peacefully on Jan. 30, 2020, in his beloved El Dorado wine region home of Camino, California. Dick is survived by his partner in life and work, Leslie Bush. He is also survived by his four children. A memorial in Dick Bush's memory was held February 22nd at the Federated Church in Placerville, Calif.



Richard Harding (Dick) Bush

The Sonoma Valley Vintners & Growers Alliance (SVVGA) announced new leadership to the marketing organization's board of directors. Prema Behan, general manager of Three Sticks Wines and Head High Wines has been appointed as president of the board of directors. Erich Bradley of Pangloss Cellars, Repris and Sojourn Cellars was elected as vice president. Lauren Benward of Beltane Ranch was named secretary. Steven Sangiacomo of Sangiacomo Family Vineyards was appointed treasurer. New board directors elected include Justin Bain of MacArthur Place; Anne Moller-Racke of Stone Edge Farm Estate Vineyards & Winery and Blue Farm Wines; Tom Rouse of Landmark Vineyards; Brenae Royal of E. & J. Gallo Winery – Monte Rosso Vineyard and Chris Sebastiani of Viansa Sonoma Winery.

The New York Wine & Grape Foundation presented the 2020 Jim Finkle Industry Award to Peter Bell, Fox Run winemaker, honoring his long-standing commitment to the Finger Lakes and New York wine industry on February 26, 2020. The award honors those who believe in "collaboration at all levels." Bell has been the winemaker at Fox Run Vineyards for 25 years and serves as a consultant and mentor to dozens of winemakers within the region. **WBM**



Legal Counsel to the Beverage Industry

- Applications for ABC and TTB licenses
- Distribution agreements & direct shipping advice for all states
- ABC and TTB Business Practice Counseling
- Accusation, Defense and Protest Hearing Representation
- Regulatory clearance of promotions, point-of-sale material, labels and advertising

ATTORNEYS:
John Hinman
Beth Aboulafia
Rebecca Stamey-White
Suzanne DeGalan
Sara Mann
Erin Kelleher
Gillian Garrett
Barbara Snider

260 California Street, Suite 700
San Francisco CA 94111
Telephone 415.362.1215
Facsimile 415.362.1494
beveragelaw.com

Company	web address	page
Ager Tank & Equipment Co.	www.agertank.com	45
American AgCredit	www.agloan.com	69
American Society for Enology and Viticulture	www.asev.org	28
American Vineyard Foundation	www.avf.org	85
Amorim Cork America	www.amorimca.com	11
Ardagh Group, Glass - North America	www.ardaghgroup.com	7
ARS/SWASH Sanitizing Equipment	www.swashequipment.com	34
ATPGroup	www.atpgroup.com	29
Avian Control Bird Repellent	www.aviancontrol.com	77
Barrel Builders, Inc.	www.barrelbuilders.com	49
Bergin Screen Printing and Etching	www.berginglass.com	9
Berlin Packaging	www.berlinpackaging.com	4, 5
Bin to Bottle Winery	www.bintobottle.com	57
Black Stone Ventures	www.bsvtanks.com	77
Boswell Co.	www.boswellcompany.com	61, 66
Bouchard Cooperages	www.bouchardcooperages.com	44
BSG Wine	www.bsgwine.com	35
CanSource	www.cansource.com	26
Canton Cooperage	www.cantoncooperage.com	35
Carlsen & Associates	www.carlsenassociates.com	42
Coastal Viticultural Consultants, Inc.	www.coastalvit.com	70
ColloPack Solutions	www.collopack.com	17
Craft Canning + Bottling	www.craftcanning.com	64
Creative Oak	www.creativeoak.com	31
Della Toffola USA, Ltd.	www.dellatoffola.us	27
EMC Insurance	www.emcins.com	105
ETS Laboratories	www.etslabs.com	116
Euro-Machines, Inc.	www.euromachinesusa.com	54
FedEx®	www.fedex.com	99
Free Flow Wines	www.freeflowwines.com	39
G3 Enterprises	www.g3enterprises.com	115
GAI America Inc.	www.gai-america.com	58
Gallo Glass Co.	www.galloglass.com	13
Garton Tractor, Inc.	www.gartontractor.com	70
Global Package, LLC	www.globalpackage.net	101
GOfermentor	www.gofermentor.com	19
Gomberg, Fredrikson & Associates	www.gfawine.com	86
Guala Closures North America	www.gualaclosures.com	91
Gusmer Enterprises	www.gusmerwine.com	32
Hall & Bartley, Architecture-Planning	www.hallandbartley.com	100
Hinman & Carmichael, LLP	www.beveragelaw.com	111
Hoyt Shepston, Inc.	www.hoyt-shepston.com	100
Industrial Fumigant Co	www.indfumco.com	102
Iron Heart Canning Co.	www.ironheartcanning.com	28
M.A. Silva USA	www.masilva.com	37
Mahindra	www.mahindra.com	51
Maverick Enterprises, Inc.	www.maverickcaps.com	93

Company	web address	page
MetLife Investment Management's Agricultural Finance Group	www.metlife.com/ag	45
Microworks Wine Software	www.winesoftware.com	101
Monvera Glass Décor	www.monvera.com	89
Nadalié USA	www.nadalie.com	41
Napa Fermentation Supplies	www.napafermentation.com	64
Oak Solutions Group	www.oaksolutionsgroup.com	18
Oenofrance USA, LLC	www.oenofrance.com	26
P&L Specialties	www.pnlspecialties.com	22
PakTech	www.paktech-opi.com	47
Parsec SRL	www.parsec.srl	29
Pasco Poly, Inc.	www.pascopoly.com	102
Portocork America	www.portocork.com	3
PowerOn Solutions	www.poweronsolutions.com	83
Prospero Equipment Corp.	www.prosperequipment.com	48
Quercus Concepts	www.oakalternatives.com	33
Research Oenovation Collective	www.rocwine.org	65
Rose City Transportation Co.	www.rosecitytransinc.com	103
Sanitary Stainless Welding	www.sanitarystainless.com	52
Saverglass, Inc.	www.saverglass.com/en	2
Saxco International	www.saxco.com	75
Scott Laboratories, Inc.	www.scottlab.com	25
Seguin Moreau Napa Cooperage	www.seguinmoreaunapa.com	32, 33
Shelco Filters	www.shelco.com	72
Sonoma Cast Stone	www.concretewinetanks.com	59
Spec Trellising	www.spectrellising.com	72
Speidel Tank	www.speidel-behaelter.de	40
Squid Ink Manufacturing	www.squidink.com	21
St. Patrick's of Texas	www.stpats.com	55
StaVin, Inc.	www.stavin.com	63
Tom Beard Co	www.tombeard.com	42
Tonnellerie de Mercurey USA, Inc	tonnellerie-de-mercurey.com	23
Tonnellerie Sirugue	www.sirugueusa.com	34
UC Davis Continuing and Professional Education	cpe.ucdavis.edu/areas-study/winemaking	22
United Bottles & Packaging	www.unitedbottles.com	82
Vacuum Barrier Corp.	www.vacuumbarrier.com	20
Vicard USA	www.groupe-vicard.com	43
Vineyard Economics Symposium	www.vineyardeconomics.com	73
Vinoseal	www.vinoseal.us	67
Waterloo Container Co.	www.waterloocontainer.com	15
Wine Institute	www.wineinstitute.org	107
Winejobs.com	www.winejobs.com	109
Wines & Vines Directory/Buyer's Guide	www.winesvinesanalytics.com/store	106
Wines Vines Analytics	www.winesvinesanalytics.com	60
Wonderful Nurseries	www.wonderfulnurseries.com	71
World Cooperage	www.worldcooperage.com	53
XtraChêne	www.xtrachene.fr	34
YompBox	www.yompbox.com	103
Zenport Industries	www.zenportindustries.com	72

“Looking back on 20+ years of reading *WBM* and what others have written here, it’s the breadth of topics and varied angles that makes the difference: the POS assessments provide an easy way to evaluate different systems against our own requirements; Bill Pregler’s ‘What’s Cool’ always opens my eyes to new possibilities; Mark Greenspan’s vineyard insights help keep focus on long-term goals. I always enjoy Jake Lorenzo’s take and learning how other winemakers go about our craft. Most important to our industry, however, is almost anything that raises consciousness about continual improvement through a sustainable winegrowing program.

One story that changed things at Cooper-Garrod? The Roussanne/Viognier mix-up 20 years ago. The *WBM* article that a Roussanne vineyard was really Viognier came out while we were preparing our first Roussanne bottling. Lo and behold, our planted Roussanne was, indeed, from that Viognier lineage, and we labeled the first Randall Grahm clone Viognier!!”

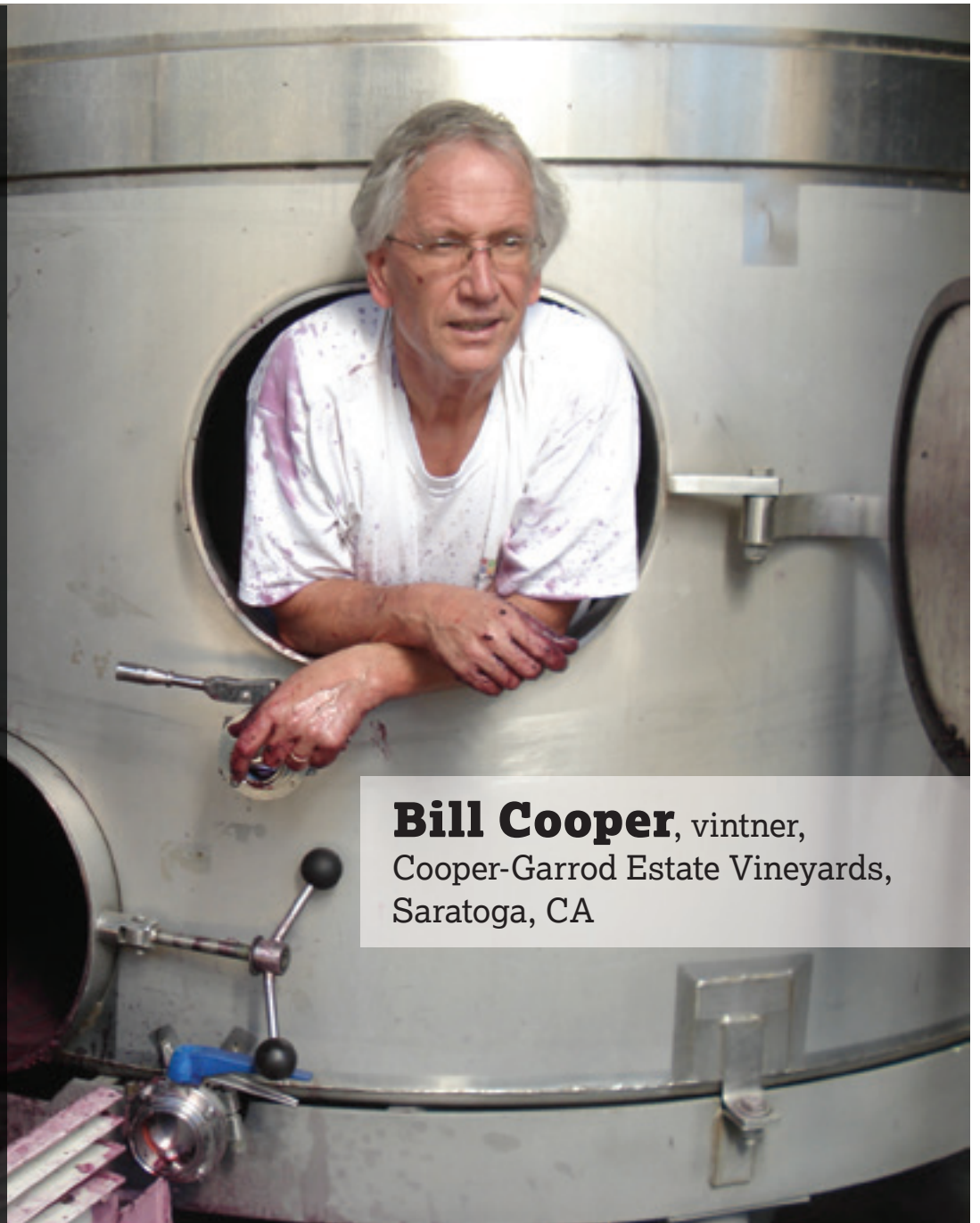

Bill Cooper, vintner,
Cooper-Garrod Estate Vineyards,
Saratoga, CA

NAME AND TITLE: Bill Cooper, vintner

WINERY/VINEYARD: Cooper-Garrod Estate Vineyards, Santa Cruz Mountains AVA, Saratoga, CA

Our hillsides have been family ag since our Garrod great-grandparents started here in 1893 as English immigrants. Originally prune and apricot orchards, in the mid-1900s the property evolved into a thriving equestrian operation, which continues even now. The first vineyard was Cabernet Sauvignon, planted in 1972 with my NASA test pilot dad, George Cooper, looking to make wine as a retirement hobby. After 20 years making wine for the family—and more varieties planted—it was 1994 when the Cooper-Garrod label was first seen in the marketplace. Now you have a fun bunch of fourth and fifth generation cousins who enjoy growing grapes and making nice wines for our clientele.

ANNUAL CASE PRODUCTION: 2,000 cases

PLANTED ACRES: 28—CCOF-Certified Organic and CCSW-Certified Sustainable

CAREER BACKGROUND: My first career was in the Foreign Service. In 1996, two years into the Cooper-Garrod launch, I left the Foreign Service to return home and learn winemaking and sales. In 2001, I joined the Joint Committee on Sustainable Winegrowing—anticipating I would learn something with all those smart people in the room—and made more professional friendships around the state than I ever imagined possible; I ended up serving nine years on the CSWA board. In 2005, Cooper-Garrod began the transition to organic farming and, in 2010, we were one of the first three winery/vineyard operations in the state to be certified sustainable by the California Sustainable Winegrowing Alliance. Also, I’m in my second decade as a Wine Institute District Director.

WHAT HAS BEEN YOUR BIGGEST PROFESSIONAL CHALLENGE? The first five years, when we moved from the caves at Mount Eden Vineyards to our new on-site facility. In addition to extension courses at Davis, being in the Santa Cruz Mountains gave me access to legendary winemakers of the likes of Mount Eden, Ridge and Kathryn Kennedy, who freely shared ideas and lessons learned.

VARIETALS THAT YOUR WINERY IS KNOWN FOR: Cabernet Franc, Cabernet Sauvignon, Chardonnay, Viognier, Pinot Noir, Syrah and Test Pilot blends from these estate grapes.

In the Trenches

JAKE LORENZO IS A one-man operation. There is no secretary, receptionist or assistant investigator. I've got an office; but if I am not there, then it is closed. I have a telephone, but rarely do I answer it, so leave a message and I'll get back to you. However calamitous your situation, it probably won't get inordinately worse in a couple of hours. It's Sonoma, after all.

If you are looking for froufrou, then Jake Lorenzo is not your guy. Clients impressed by fancy offices, expensive coffee and investigators wearing high-priced suits shouldn't be looking for this detective. On the other hand, when you hire Jake Lorenzo, you *get* Jake Lorenzo. I do the work. I pore through information on the computer, sit in the car on surveillance and confront people trying to bother you. I'm in the trenches, doing the job because I like the work. It may not seem like much, but it matters to this detective.

Being in the trenches is not just a saying. When we built my house, we dug trenches for the foundation by hand. Talk about back-breaking work, using picks and shovels to dig foundation trenches almost killed this detective, but the walls of those trenches were straight, and there was no overflow of concrete, which saved us a lot of money. It doesn't matter what type of work you are doing: if you are in the trenches, it is hard.

I admire winemakers who provide food and beer every day for their crew during harvest, and I venerate winemakers who stay late occasionally to sterilize the hoses while sending their crew home for an early dinner.

Whatever the endeavor, I am most interested in people doing the actual work. There is a gentleman here in Sonoma whose name is Jesus Barragan. A Mexicano well over 6 feet tall, he is a master at trimming trees. Whenever I hire him to work around my property, I marvel at his ability to climb giant oak trees, tie ropes in the perfect configuration and then wield his chain saw to slash through broken limbs or rotting trunks until the pieces dangle freely from the ropes and they are lowered to the ground by his crew. Jake Lorenzo can watch Mr. Barragan work for hours. There is a rhythmic grace to his work and the growl of his chain saw that mesmerizes this detective.

That same grace is present when Chuy Palacios cooks. There is no "Executive" in Chuy's title. In fact, he doesn't even like the term "chef." You can find him in front of the stove every day, usually with no more than one person to help. He preps for hours, slicing, dicing, making sauces, and then he puts things together effortlessly on simply composed plates, brimming with flavor. Fascinated by food and spices, he can spend days, developing a dish. He experiments and tastes and tweaks and adjusts, until he thinks it is just right. Only then will he add an item to his menu.

When necessary, he will cook, plate up and serve his customers. He'll collect dishes and wipe up tables when they leave. That's why waiters love Chuy Palacios. He's in the trenches with them, and he pays for their healthcare, feeds

them every day and gives them the opportunity to make good money on tips because his place is always packed with customers. When the day is done, Chuy Palacios is sweaty, his clothes are spotted, and he collapses into a chair so fully exhausted that an ice-cold beer becomes the perfect exclamation point to his day.

Some winemakers choose to sit in lush offices in front of computers, typing up work orders. They sit on panels at trade shows, bore people to death speaking about fermentation science at winemaker dinners or continuously lunch with salespeople who are trying to get their business. Other winemakers can interview prospective employees, give the VIP tours and opt for gin and tonics when they get home from work. Those are not the winemakers I hang out with. They wouldn't know a trench if they fell into one.

Jake Lorenzo looks for winemakers with worn rubber boots. I like winemakers whose hands are stained black during harvest. Give me a winemaker who knows how to scrub the inside of a tank, and break down, clean and reassemble a tank valve. I am impressed with a winemaker who has changed out the bladder on a bladder press by himself, who drives forklifts like a pro and who works every position on the bottling line.

I admire winemakers who provide food and beer every day for their crew during harvest, and I venerate winemakers who stay late occasionally to sterilize the hoses while sending their crew home for an early dinner. You have to appreciate any winemaker who respects his cellar rats while working side by side with them, who learns enough Spanish to get a laugh out of his Mexicano workers and who understands how vital they are to the quality of our finished product.

After all these years, Jake Lorenzo admits I'm not that keen on talking about wine, but I still love to drink it. I like to hear the pop of a cork and the glug of that first pour into a glass. Sniffing the aromas, coming from the glass relaxes me, and that first sip, dancing on the tongue, melts away any tension built up over the day. If I can, I like to sit on the porch, watching birds flit around the flowers in Jakelyn's mother's garden while I slowly drink that first glass. In the winter, I'll sit by the fireplace, sipping that first glass while pondering important things.

I ponder how you can consider yourself a winemaker if you come home to gin and tonics instead of wine. I wonder how you can be a chef if you never cook in the kitchen or a tree cutter if you never cut trees. Are you really a detective if you never go on a surveillance or spend hours digging up dirt on a suspect? Even writers have to sit at the keyboard and bang out their ideas, choosing which words to use and how to put the sentences together. Being in the trenches for a writer is coming up with the idea and then finding a way to get it onto the paper.

There has always been a connection between writers and drinkers. Many great writers have been known to drink a lot, and for many of them the drink of choice is wine. It is for Jake Lorenzo, and I can type until my fingertips are sore so long as my reward is a good bottle of wine. To be honest, my fingertips are already a bit tender, so I'm headed to my wine cellar for my reward. **WBM**



AG HAULING | **OAK ALTERNATIVES** | WINE LABELS | PACKAGING SOLUTIONS | LOGISTICS

ING3NUITY IS: MODERN APPROACHES FOR TRADITIONAL TASTES.



ING3NUITY IS MORE THAN INTELLIGENCE. IT'S ADVANCED SOLUTIONS LIKE OUR BOISÉ AND PHENESSE OAK ALTERNATIVES. THEY'RE EFFICIENT, PRECISE, CONSISTENT AND YET ANOTHER CREATIVE APPROACH TO WINEMAKING FROM G3.

G3ENTERPRISES.COM





ENHANCING
CRAFT
SINCE 1978



LABORATORIES

etslabs.com